

Instruction Manual

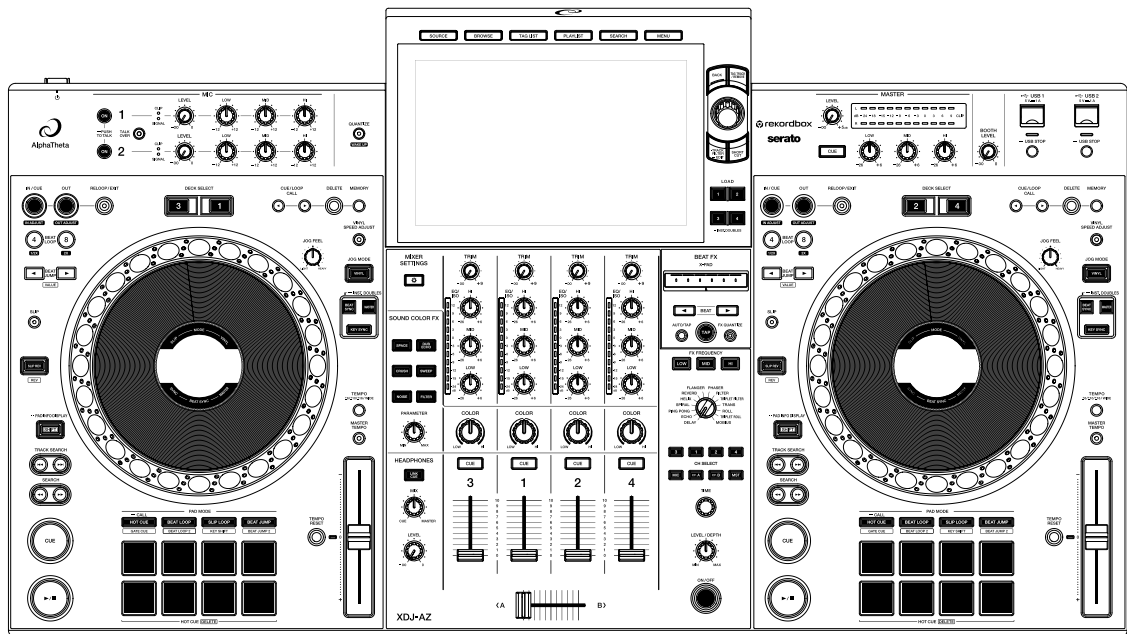

All-In-One DJ System

XDJ-AZ

alphatheta.com/support/

rekordbox.com

serato.com

For FAQ and other support information for this product, visit the websites above.

Contents

Before you start	8
How to read this manual	8
What's in the box.....	8
User guides	9
Product overview	10
System requirements	10
rekordbox for Mac/Windows.....	12
rekordbox for iOS/Android.....	14
PRO DJ LINK	15
Serato DJ Pro.....	15
PC/Mac setup	16
Setting Utility	19
rekordbox CloudDirectPlay	21
Using rekordbox CloudDirectPlay	22
Authentication device for rekordbox CloudDirectPlay	24
Checking the internet connection.....	26
Logging in to rekordbox CloudDirectPlay	27
Logging out of rekordbox CloudDirectPlay.....	27
Playing audio files via rekordbox CloudDirectPlay	28
Using rekordbox CloudDirectPlay with Beatport Streaming.....	28
StreamingDirectPlay	29
Logging in to Beatport Streaming.....	29
Logging out of Beatport Streaming	30
Playing audio files via Beatport Streaming.....	30
Part names	31
Top panel	31

Front panel	32
Rear panel.....	32
Touchscreen	34
Jog display	42
Basic operations on the touchscreen	43
Connections (basic styles)	45
PRO DJ LINK	45
Connecting storage devices.....	49
USB section	49
USB device	50
Track selection.....	51
Browse section	51
Selecting a source.....	52
Selecting a track.....	52
Searching for a track	53
Monitoring sound before loading a track (Touch Preview).....	57
Loading a track to a deck	57
Using History	59
Using the Tag List	60
Displaying the playlist screen.....	64
Playback	67
Deck section.....	67
Play/pause	68
Playing a track from the touched point on the overall waveform.....	69
Reverse playback.....	69
Basic operations during playback	70
Adjusting the playback speed (tempo control)	70
Adjusting the playback speed without changing the pitch (Master Tempo).....	71
Monitoring a different part of a track during playback (Touch Cue)	71

Recording	72
Splitting a track during recording.....	72
Using the jog wheel	73
Jog wheel section.....	73
Setting the jog wheel mode.....	74
Jog wheel operations.....	74
Adjusting the “weight” of the jog wheel.....	75
Adjusting the playback starting and stopping speeds (for Vinyl mode).....	75
Cueing	76
Setting a cue point.....	76
Jumping to a cue point.....	76
Checking a cue point (Cue Point Sampler).....	77
Saving a cue point.....	77
Calling up a saved cue point.....	77
Deleting a saved cue point.....	78
Setting Auto Cue.....	78
Looping	79
Setting a loop.....	79
Fine-adjusting loop points.....	80
Adjusting the length of a loop.....	81
Returning to a loop-in point to start loop playback (Retrigger).....	81
Using Active Loop.....	82
Canceling loop playback.....	82
Emergency Loop.....	82
Saving a loop.....	83
Calling up a saved loop.....	83
Deleting a saved loop.....	83
Beat Jump/Loop Move	84
Using Beat Jump/Loop Move.....	84

Quantize (for deck)	85
Using Quantize.....	85
Slip	86
Turning Slip mode on	87
Beat Sync	88
Using Beat Sync.....	88
Using Instant Doubles	89
Beatgrid	90
Adjusting the beatgrid	90
Key Sync	91
Using Key Sync.....	91
Key Shift	92
Using Key Shift.....	92
Using the Performance Pads	93
Performance Pads section	93
Hot Cue/Gate Cue.....	94
Beat Loop.....	99
Slip Loop	100
Key Shift.....	101
Beat Jump/Loop Move	102
Audio output	103
Channel section/master section	103
Outputting sound	105
Adjusting the sound.....	106
Setting the faders	107
Monitoring sound	108
Headphones section	108
Monitoring with headphones	109
Monitoring sound with SonicLink headphones.....	109

Booth section	111
Using a booth monitor	111
Microphone	112
MIC section	112
Using a microphone	113
Reducing the “howling” noise of a microphone (Feedback Reducer)	114
Sound Color FX.....	115
Sound Color FX section	115
Using Sound Color FX	116
Sound Color FX types and settings.....	117
Beat FX	119
Beat FX section.....	119
Using Beat FX.....	121
Setting BPM manually (Tap mode)	122
Beat FX types and settings	123
Using DJ software	128
Controlling DJ software	128
Settings.....	130
Changing the settings	130
Utility settings	131
Wireless LAN (Wi-Fi®) connection.....	141
Bluetooth®/MD connection	143
Changing the settings on the Shortcut screen	145
Setting items on the Shortcut screen	146
Changing the settings on the Mixer Settings screen.....	147
Setting items on the Mixer Settings screen.....	148
Calling up My Settings saved on a USB device	149
Specifications	150
Additional information	153

Troubleshooting	153
LCD display	156
Trademarks and registered trademarks	157
Cautions on copyrights.....	158

Before you start

How to read this manual

- Thank you for choosing this AlphaTheta product.
Be sure to read this manual, the Quick Start Guide and the Precautions for Use which are also included with this product. These documents include important information that you should understand before using the unit.
- In this manual the names of buttons, knobs and terminals that appear on the product, and the names of buttons, menus etc. in the software on your PC/Mac or mobile device, are indicated within square brackets ([]). (e.g. **[File]**, **[CUE]** button)
- Please note that the software screens and their specifications, as well as the external appearance and specifications of the hardware, are subject to change without notice.
- Please note that depending on the operating system version, web browser settings, etc. operation may differ from the ways described in this manual.
- Please note that the language on the screens of the software described in this manual may differ from the language on your screen.

What's in the box

- Power cord
- Warranty (for some regions)*¹
- Precautions for Use
- Quick Start Guide

*¹ Only products in Europe and North America.

User guides

❖ rekordbox Introduction, Instruction Manual

Refer to the rekordbox Introduction to find out how to set up rekordbox for Mac/Windows, and see the Instruction Manual to find out how to use rekordbox for Mac/Windows.

Visit the URL below to find these user guides.

rekordbox.com/manual

❖ Serato DJ Pro software manual

Refer to the following Serato DJ site.

serato.com/dj/pro/downloads

Product overview

System requirements

Supported audio sources

This unit supports the following sources.

- USB device
- Mobile device (page 14)
- PC/Mac (page 16)

❖ USB devices

Use USB devices that support the following specifications.

Folder hierarchy	Up to 8 levels (Files in the lower levels can't be played with the unit.)
Maximum number of folders	Unlimited (Up to 10 000 folders in a folder can be displayed.)
Maximum number of files	Unlimited (Up to 10 000 files in a folder can be displayed.)
File format	FAT16, FAT32, exFAT, HFS+ (NTFS isn't supported.)

- The unit can play audio files saved on USB mass storage class devices.
- It may take some time for the unit to read a device when it contains many folders and files.
- Some USB devices may not work properly with this unit.
- The unit doesn't support the following.
 - Optical disc devices such as external DVD/CD drives
 - USB hubs
- We accept no responsibility for loss of data from USB devices, or other direct or indirect problems resulting from connections to this unit.
- If excessive current passes through the USB port on the unit, the USB indicator on the unit blinks, and the unit stops the power supply to the USB device and stops communication. To restore the unit to a normal condition, disconnect the USB device from the unit. Do not use the USB device with the unit again.

If you still can't restore the unit to a normal condition (i.e. if the unit doesn't communicate with a connected USB device), turn the unit off and on.

- If USB devices have multiple partitions, only the first partition can be used (or if there is a partition including rekordbox library, the partition is used instead).
- USB devices with a flash card reader may not work properly with this unit.
- Do not use an extension cable when connecting a USB device to the unit or communication may be interrupted.

Supported file formats

The unit supports audio files in the following formats.

Type	Extension	Format	Bit depth	Bit rate	Sampling frequency
MP3	.mp3	MPEG-1 AUDIO LAYER-3		32 to 320 kbps	
AAC	.m4a, .aac, .mp4	MPEG-4 AAC LC MPEG-2 AAC LC	16bit	16 to 320 kbps	44.1 kHz, 48 kHz
WAV	.wav	WAV			
AIFF	.aif, .aiff	AIFF			44.1 kHz, 48 kHz,
Apple Lossless	.m4a	ALAC	16bit, 24bit	—	88.2 kHz, 96 kHz
FLAC	.flac, .fla	FLAC			

- Some files can't be played with the unit even if they are in a supported format.

Tag information

This unit can read tag information from ID3 tags (v1, v1.1, v2.2.0, v2.3.0, v2.4.0) and meta tags set in audio files.

Artwork of audio files

You can add an artwork image in JPEG format (extensions: “jpg”, “jpeg”) to each audio file. Images larger than 800 x 800 pixels can't be displayed on this unit.

Display language

If you want to display characters (track names, etc.) in local codes other than Unicode, change the [**Language**] setting (page 139).

rekordbox for Mac/Windows

rekordbox for Mac/Windows is a complete DJ application that you can use to manage your music and perform.

- You can use audio files managed in Export mode (the music management function of rekordbox for Mac/Windows) with this unit.
- This unit is a Hardware Unlock device. If you connect a PC/Mac running rekordbox for Mac/Windows to the unit, you can use Performance mode (DJ functions of rekordbox for Mac/Windows) for free.
- For information on functions supported by Hardware Unlock, visit the URL below.
rekordbox.com
- The rekordbox for Mac/Windows isn't included with the unit. Download the software from the URL below.
rekordbox.com
- For information on the latest system requirements, compatibility, and supported operating systems, visit the URL below.
rekordbox.com/system

- Operation isn't guaranteed on all PC/Mac models, even if the system requirements are met.
- Depending on power-saving settings and other conditions of your PC/Mac, the CPU and hard disk may not provide sufficient processing capabilities. For laptops in particular, make sure the PC/Mac is in the best condition to provide constant high-level performance when using rekordbox for Mac/Windows (for example by keeping the AC power connected).

Device Library Plus

This unit only supports the Device Library Plus format.

Before you use this unit with a USB device which has another library type, convert the library via the following procedure.

- 1 Launch the latest version of rekordbox for Mac/Windows.**
- 2 Connect the USB device to your PC/Mac.**
- 3 Follow the on-screen instructions to perform the conversion.**

- For information on Device Library Plus, refer to the FAQ at the URL below.

rekordbox.com/support/faq/devicelibraryplus-6/

rekordbox for iOS/Android

If you connect mobile devices running rekordbox for iOS/Android to the unit, you can play audio files managed in rekordbox for iOS/Android via the unit.

- For information on connecting mobile devices running rekordbox for iOS/Android with the unit, refer to the FAQ at the URL below.

iOS:

rekordbox.com/en/support/faq/connecting-to-dj-units/#faq-q100037

Android:

rekordbox.com/en/support/faq/connecting-to-dj-units-android/#faq-q110039

- The DJ performance functions supported by ver. 4.0.0 or later can't be used with this unit. Select [**Connect to CDJ/XDJ/DJM**] on the screen below and use the unit via PRO DJ LINK.

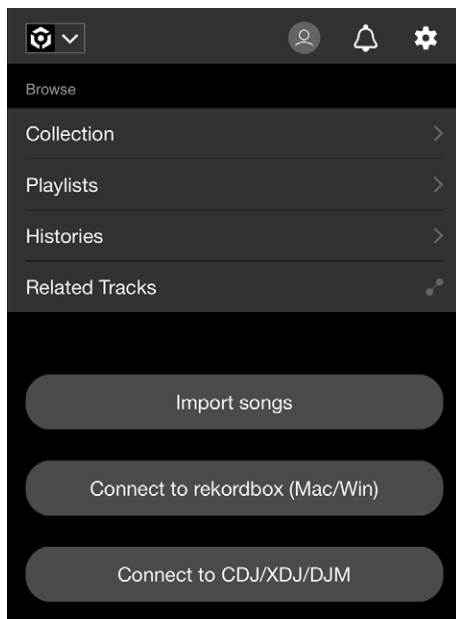

PRO DJ LINK

PRO DJ LINK supports USB Export, which utilizes a USB device, as well as rekordbox Link Export, which utilizes a PC/Mac or mobile device running rekordbox.

You can connect up to 2 players that support PRO DJ LINK using a LAN cable (CAT5e) and a switching hub.

➤ Read more: PRO DJ LINK (page 45)

Serato DJ Pro

Serato DJ Pro is DJ software from Serato.

The Serato DJ Pro software isn't included with the unit. Download the software from the URL below.

serato.com

- For information on the latest system requirements, compatibility, and supported operating systems, visit the URL below.

serato.com/dj/pro/downloads

- Operation isn't guaranteed on all PC/Mac models, even if the system requirements are met.
- Depending on power-saving settings and other conditions of your PC/Mac, the CPU and hard disk may not provide sufficient processing capabilities. For laptops in particular, make sure the PC/Mac is in the best condition to provide constant high-level performance when using Serato DJ Pro (for example by keeping the AC power connected).

PC/Mac setup

To input your PC's audio to the unit, install the following software on your computer. If you use a Mac, you don't have to install the dedicated audio driver software and rekordbox for Windows USB connection (Link Export) driver software.

– Dedicated audio driver software:

Driver software used for inputting the PC audio to the unit.

If you install the dedicated audio driver software, Setting Utility will also be installed with the driver software (page 18).

– rekordbox for Windows USB connection (Link Export) driver software:

Driver software used for connecting a PC running rekordbox for Windows to the unit via USB (Link Export)

For information on the installation, visit the URL below.

alphatheta.com/support/

- For information on the latest system requirements, compatibility, and supported operating systems, visit the URL below.

alphatheta.com/support/

- Operation isn't guaranteed on all PC/Mac models, even if the system requirements are met.
- Operation isn't guaranteed when multiple units are connected to a PC/Mac.
- If a PC without the audio driver software installed is connected to the unit, errors may occur on the PC.
- Malfunctions may occur due to incompatibility with other software installed on a PC/Mac.

Installation of the dedicated audio driver software

❖ Notes on installation

- Turn the unit off and disconnect the USB cable connected to the unit and the PC before installation.
- Close all applications running on the PC before installation.
- You'll need admin rights to install the audio driver software to your PC.
- Read the License Agreement terms carefully before installation.
- If you quit the installation halfway through, perform the installation procedure from the beginning again.
- After the installation is complete, connect the PC to the unit.
- Operation isn't guaranteed on all PC models.

Downloading the dedicated audio driver software

1 Visit the URL below.

alphatheta.com/support/

2 Click [software & firmware updates].

3 Click [XDJ-AZ] under [ALL-IN-ONE DJ SYSTEM].

4 Click [Drivers].

5 Click [Download link] and save the file.

- Download the audio driver software dedicated to your PC.

Installing the dedicated audio driver software

1 Unzip the downloaded audio driver software.

- Unzip “XDJ-AZ#####.exe.zip” (# indicates the version number of the software).

2 Double-click the downloaded installation file.

- Double-click “XDJ-AZ#.###.exe” (# indicates the version number of the software).

3 Read the License Agreement terms carefully.

If you agree to the terms, mark the [Agree] check box and click [OK].

- If you don't agree to the License Agreement terms, click [Cancel] to cancel the installation.

4 Follow the on-screen instructions to complete the installation.

Setting Utility

Once you've installed the driver software on your PC, you can use the Setting Utility for the following.

- Adjusting the buffer size (for Windows ASIO) (page 20)
- Checking the software versions (page 20)

Launching Setting Utility

❖ For Windows 11

- 1 Open the Start menu and click [All Apps] → [AlphaTheta] → [XDJ-AZ Setting Utility].

❖ For Windows 10

- 1 Open the Start menu and click [AlphaTheta] → [XDJ-AZ Setting Utility].

Adjusting the buffer size (for Windows ASIO)

- Close any running applications (DJ applications, etc.) which use the unit as the default audio device before adjusting the buffer size.

➡ Read more: Launching Setting Utility (page 19)

1 Click the [ASIO] tab.

2 Adjust the buffer size with the slider.

- Breaks in sound are less likely to occur if you set a large buffer size, but this increases lag time due to the latency of audio data transmission.

Checking the software versions

➡ Read more: Launching Setting Utility (page 19)

1 Click the [About] tab.

The software versions are displayed.

rekordbox CloudDirectPlay

With rekordbox CloudDirectPlay, you can load and play audio files you've previously uploaded to your cloud storage onto the unit.

- Use Cloud Library Sync to upload audio files to your cloud storage. You can then play the uploaded files via your PC/Mac, mobile device, or this unit.
- For information on Cloud Library Sync, see the Cloud Library Sync Operation Guide.

rekordbox.com/manual

For information on how to manage audio files uploaded to your cloud storage, refer to the website at the URL below.

rekordbox.com

❖ rekordbox version

Install the latest version of rekordbox to use rekordbox CloudDirectPlay with this unit.

❖ Subscription

You can use rekordbox CloudDirectPlay with all rekordbox subscription plans, including the Free plan.

- For information on rekordbox plans, see the plan page at the URL below.

rekordbox.com

❖ Cloud storage service

rekordbox CloudDirectPlay uses the cloud storage service used by Cloud Library Sync.

- Cloud Library Sync and rekordbox CloudDirectPlay support Dropbox and Google Drive.
- For more information, see the Cloud Library Sync Operation Guide.

rekordbox.com/manual

❖ Transmission speed

The time it takes to sync your library and load audio files via rekordbox CloudDirectPlay depends on the speed of your internet connection. We recommend a line speed of 20 Mbps or faster for using rekordbox CloudDirectPlay.

❖ Personal use

With rekordbox CloudDirectPlay, you can use your rekordbox library on multiple PCs/Mac computers, mobile devices, and this unit, but you can't share your library with other users.

Using rekordbox CloudDirectPlay

- 1 Click  at the top right of the screen of rekordbox for Mac/Windows.

The [Preferences] window opens.

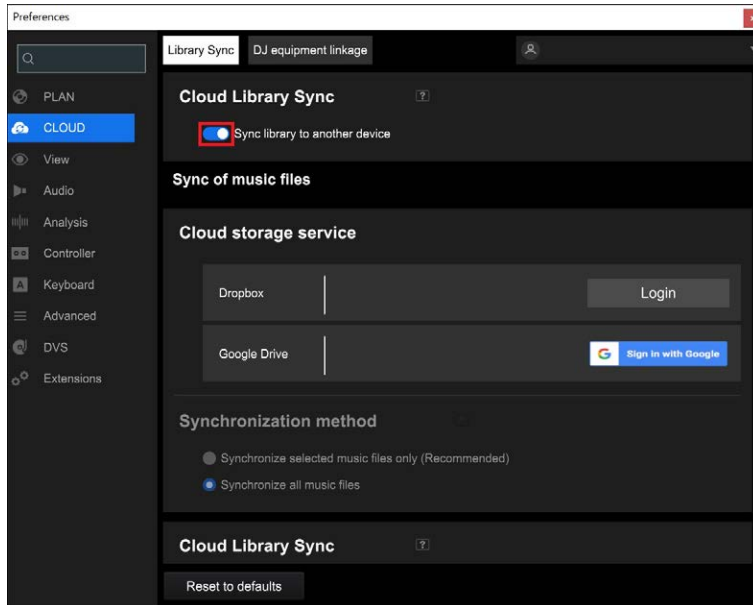

- 2 Click the [Library Sync] tab in the [CLOUD] category.
- 3 Check if [Sync library to another device] is turned on in [Cloud Library Sync].
- 4 Click the [DJ equipment linkage] tab in the [CLOUD] category.
- 5 Turn on [Use rekordbox CloudDirectPlay] in [Cloud Analysis/rekordbox CloudDirectPlay].

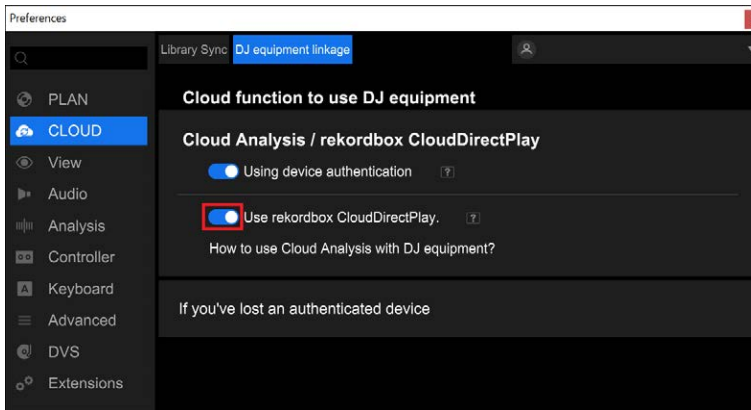

The conversion of the library starts on the cloud server.

After the conversion completes, [ **Auth**] (authentication button) is displayed on the right of the device name in the tree view.

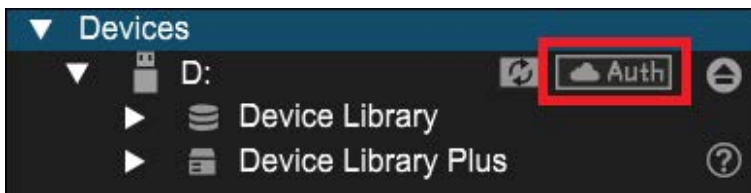

- Depending on the number of audio files in the library, it may take some time to convert the library.
- If the library conversion fails, [**Use rekordbox CloudDirectPlay**] is automatically turned off. If the conversion error happens repeatedly, contact us for support via the URL below.
rekordbox.com
- If you turn off [**Use rekordbox CloudDirectPlay**], the authentication for all devices used with the same account is canceled.
- If you turn off [**Use rekordbox CloudDirectPlay**] and turn it on, the library is converted again.

Authentication device for rekordbox CloudDirectPlay

To play audio files with the unit via rekordbox CloudDirectPlay, prepare a USB device to use for authentication.

Connect the USB device to your PC/Mac and perform the authentication procedure below.

Authenticating the USB device

- 1 Connect the USB device to your PC/Mac.
- 2 Click  **Auth** (authentication button) on the right of the device name in the tree view.

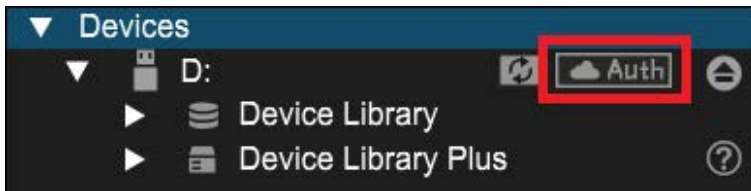

After the authentication completes,  **Auth** (authentication button) changes to  (authenticated icon).

Deauthenticating the USB device

- 1 Click  (authenticated icon) on the right of the device name in the tree view.

The USB device is deauthenticated.

- If the USB device has been authenticated with a rekordbox account other than the one you're currently using, perform the procedure with the other account.
- If the USB device has been authenticated with another user's account:
 - Connect the USB device to the PC/Mac of the user who performed the authentication for the device, then deauthenticate it.
 - Access the website from the PC/Mac of the person who performed the authentication for the device, then deauthenticate it (page 25).

Deauthenticating the USB device from the website

You can deauthenticate the USB device from the website, for example, if you lose the device.

1 Click at the top right of the screen of rekordbox for Mac/Windows.

The [Preferences] window opens.

2 Click the [DJ equipment linkage] tab in the [CLOUD] category.

3 Click [If you've lost an authenticated device].

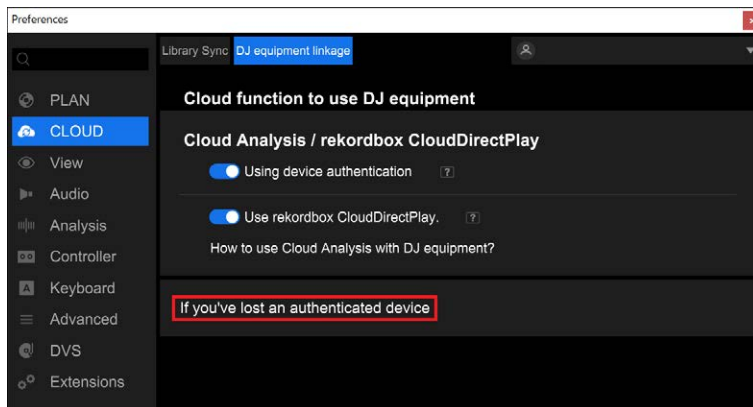

The website is displayed in the browser.

4 Follow the instructions on the website to deauthenticate the device.

- You can't deauthenticate devices authenticated with other accounts. You'll always need to perform the procedure with the account which authenticated the device.

Checking the internet connection

When rekordbox CloudDirectPlay is available, the internet connection icon is displayed on the [SOURCE] screen of the unit.

➡ Read more: Source screen (page 34)

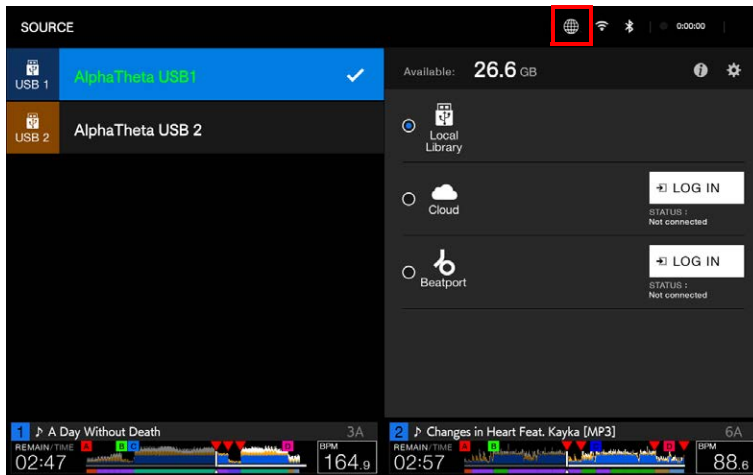

- You can't use rekordbox CloudDirectPlay when  (gray) is displayed. If this is the case, check the internet connection.

Logging in to rekordbox CloudDirectPlay

- 1 Connect the authentication USB device for rekordbox CloudDirectPlay to the unit.
- 2 Open the [SOURCE] screen.
 - ➡ Read more: Source screen (page 34)
- 3 Touch [LOG IN] for [Cloud] on the library display for the authentication USB device.

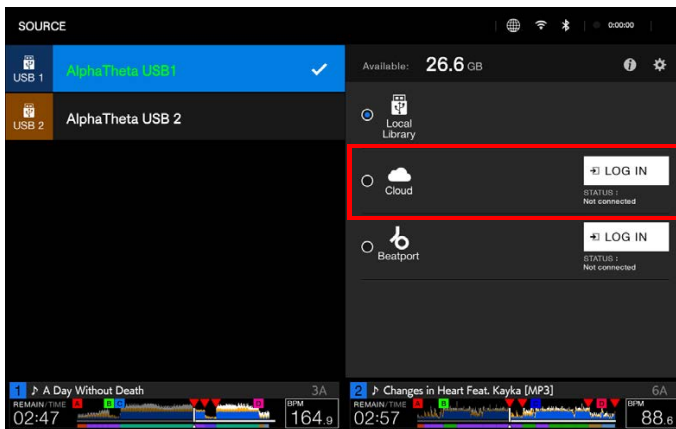

Now you can use rekordbox CloudDirectPlay.

Logging out of rekordbox CloudDirectPlay

- 1 Open the [SOURCE] screen.
 - ➡ Read more: Source screen (page 34)
- 2 Touch [LOG OUT] for [Cloud] on the library display for the authentication USB device.

Playing audio files via rekordbox CloudDirectPlay

When rekordbox CloudDirectPlay is selected on the [SOURCE] screen, audio files uploaded to your cloud storage can be played from the browse screen of the unit.

- The time it takes to load audio files depends on the speed of your internet connection. You can view the loading progress in the overall waveform on the waveform screen.
- The following playback functions are only available for loaded audio files.
 - Memory Cue/Loop
 - Hot Cue/Loop point
- Audio files are loaded one by one from the track list. The following functions aren't available.
 - Track Search
 - [Continue] in Play mode
- The following functions aren't available for rekordbox CloudDirectPlay.
 - Hot Cue Bank list
 - Intelligent playlist
- While using rekordbox CloudDirectPlay, any track information changed by other rekordbox CloudDirectPlay or Cloud Library Sync devices used with the same account isn't reflected until you log out of rekordbox CloudDirectPlay and log in again.

Using rekordbox CloudDirectPlay with Beatport Streaming

If you create playlists with tracks from Beatport Streaming using rekordbox and upload them to your cloud storage, you can load and play them on this unit.

Log in to rekordbox CloudDirectPlay and Beatport Streaming to use the tracks.

➡ Read more: [StreamingDirectPlay \(page 29\)](#)

StreamingDirectPlay

You can load and play tracks from Beatport Streaming via the browse screen of the unit.

Logging in to Beatport Streaming

1 Connect a USB device to the unit.

2 Open the [SOURCE] screen.

🔗 Read more: Source screen (page 34)

3 Touch [LOG IN] for [Beatport] on the library display for the USB device.

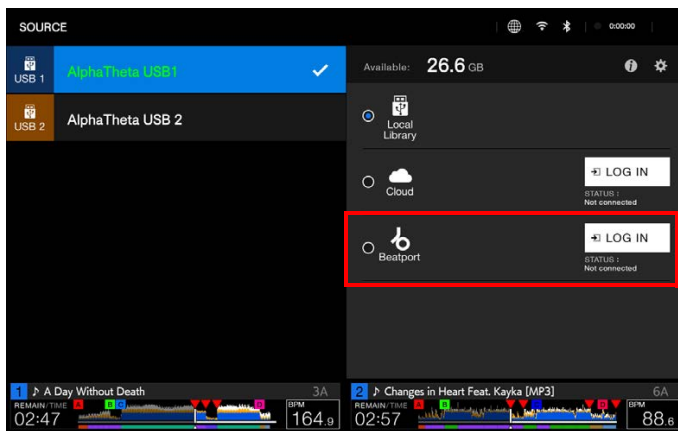

4 Log in to Beatport Streaming with your account details.

- Enter a username and password.

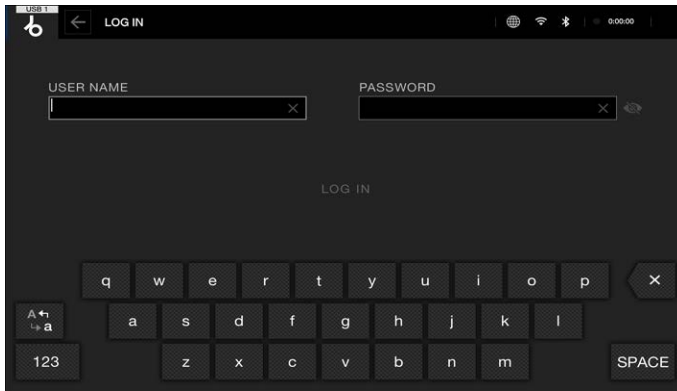

After you've logged in, [DJ NAME] is displayed on the library display for the USB device.

Logging out of Beatport Streaming

1 Open the [SOURCE] screen.

➡ Read more: Source screen (page 34)

2 Touch [LOG OUT] for [Beatport] on the library display for the USB device.

Playing audio files via Beatport Streaming

When Beatport Streaming is selected on the [SOURCE] screen, audio files from Beatport Streaming can be played from the browse screen of the unit.

- The time it takes to load audio files depends on the speed of your internet connection. You can view the loading progress in the overall waveform on the waveform screen.
- The following playback functions are only available for loaded audio files.
 - Memory Cue/Loop
 - Hot Cue/Loop point
- Audio files are loaded one by one from the track list. The following functions aren't available.
 - Track Search
 - [Continue] in Play mode

Part names

Top panel

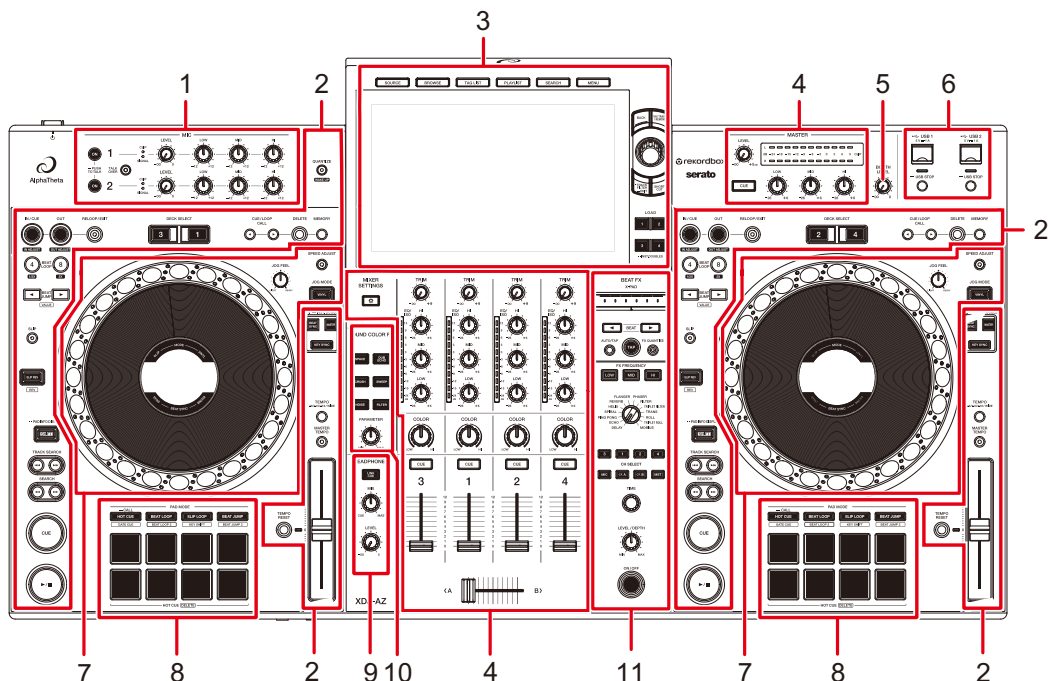

1. **MIC section** (page 112)
2. **Deck section** (page 67)
3. **Browse section, Touchscreen** (pages 34, 51)
4. **Channel section/Master section** (page 103)
5. **BOOTH section** (page 111)
6. **USB section** (page 49)
7. **Jog wheel section** (page 73)
8. **Performance Pads section** (page 93)
9. **Headphones section** (page 108)
10. **Sound Color FX section** (page 115)
11. **Beat FX section** (page 119)

Front panel

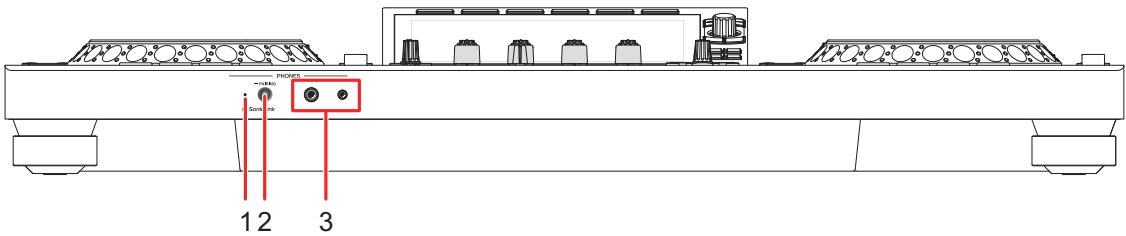

1. **SonicLink headphones indicator** (page 109)
2. **PAIRING button** (page 109)
3. **PHONES terminals** (page 108)

Connect headphones to one of the terminals (1/4" stereo jack or 3.5 mm stereo mini jack). Using both terminals at the same time may lower the sound quality or volume level.

Rear panel

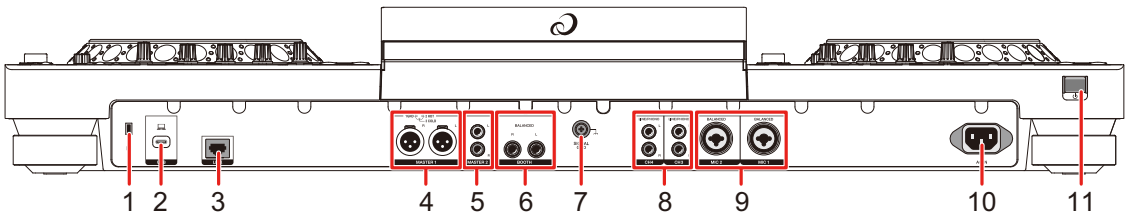

1. **Kensington security slot**
Connect a cable lock.
2. **USB port** (page 46)
Connect a PC/Mac.
3. **LINK port** (page 47)
Connect to a LAN port on a PRO DJ LINK compatible player or a PC/Mac running rekordbox.
 - To connect to a LAN port on a PRO DJ LINK compatible player, set [**PRO DJ LINK Mode**] to [**On**] in the Utility settings (page 133).
 - For wired LAN connections, use a CAT5e (or higher) STP cable.
4. **MASTER 1 terminals (balanced XLR)**

Connect to analog input terminals on a power amplifier and powered speakers, etc.

- Use the terminals for balanced output only. Connecting the terminals to unbalanced inputs (RCA, etc.) with an XLR-RCA conversion cable (conversion adapter), etc. results in unwanted noises and/or poor sound quality.
- Do not connect a power cord from another product to the terminals.
- Do not connect to a terminal that can supply phantom power.
- Use the [**MASTER 2**] terminals for unbalanced input (RCA, etc.).

5. **MASTER 2 terminals (RCA)**

Connect to analog input terminals on a power amplifier, etc.

6. **BOOTH terminals (1/4"/6.35 mm, TRS)** (page 111)

Connect a booth monitor.

- Use the terminals for balanced output only. Connecting the terminals to unbalanced inputs results in unwanted noises and/or poor sound quality.

7. **Signal GND terminal**

Connect a turntable's ground wire.

Reduces unwanted noises that occur when a turntable is connected to the unit.

8. **LINE/PHONO terminals (RCA)**

Connect multi players, line-level output devices, or phono-level (MM cartridge) output devices.

- A loud volume may be output depending on the input signal. Make sure that the input signal matches the settings.

9. **MIC 1 terminal, MIC 2 terminal (XLR or 1/4"/6.35 mm, TRS)** (page 113)

10. **AC IN**

Connect to a power outlet with the supplied power cord.

11. **⏻ button**

Turns the unit on and off.

Touchscreen

➤ Read more: Browse section (page 51)

Source screen

Press the [SOURCE] button to display the source selection screen.

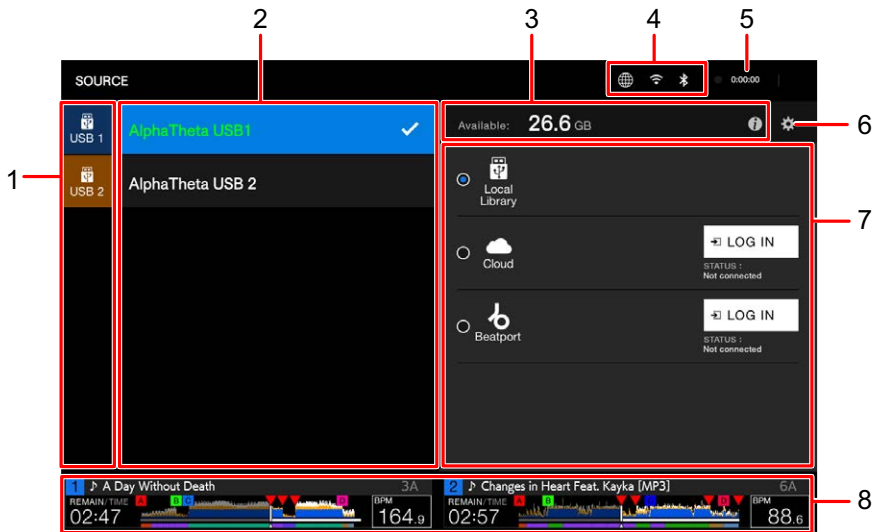

1. Device icon

Displays the connected device.

- If [Background Color] is set for the device, the icon's background is displayed in the chosen color.

2. Device name/status



Displays the device name and status.

3. Device information

Displays the free space available in the highlighted device.

Touch  to display the information for the highlighted device.

4. Connection status icons

-  (Internet connection icon): Displays the status of the internet connection.
-  (Wi-Fi connection icon): Displays the status of the Wi-Fi connection. Touch to display the Network category of the Utility settings.
-  (Bluetooth connection icon): Displays the status of the Bluetooth connection. Touch to display the Bluetooth category of the Utility settings.

5. **Rec timer**

Displays the recording time when using Master Rec (page 72). Touch to display the **[MIXER SETTINGS]** screen.

6. **(Device setting)**

Select a device or cloud storage to set the following.

- **[Waveform Color]:** Sets the waveform color.
- **[Background Color]:** Sets the background color saved on the selected USB device. This setting is also applied to colors for a part of the touchscreen.
- **[MY SETTINGS LOAD]:** Calls up the Utility settings and some other settings saved on the selected USB device (page 149).

7. **Library display**

Displays the library.

- **[Local Library]:** Browses the rekordbox library on the selected USB device.
- **[Cloud]:** Browses the rekordbox library in your cloud storage (page 21).
- **[Beatport]:** Browses Beatport Streaming (after you've logged in to it) (page 29).

8. **Deck display**

Browse screen

Press the **[BROWSE]**, **[TAG LIST]**, or **[PLAYLIST]** button to display the browse screen (track list).

You can browse a storage device, CloudDirectPlay, the rekordbox library on a connected PC/Mac or mobile device, and Beatport Streaming.

- If you browse a storage device that doesn't contain a rekordbox library on the **[BROWSE]** screen, the folder and track lists are displayed in a hierarchical structure.

When you press the **[BROWSE]** button



1. **Category**

Displays the categories.

- Go to **[Preferences]** in rekordbox to choose the categories you want to display (you can't set the categories for Beatport Streaming with rekordbox).

2. **Device icon**

Displays the icon of a device selected on the **[SOURCE]** screen (page 34).

3. **← (Back)**

Displays the next level up.

4. **Next level up display**

Displays the folder or device name in the next level up.

5. **Track list**

Displays the Preview waveform, artwork, and the track list of the selected hierarchical level or playlist.

- Touch the waveform in the **[PREVIEW]** column to monitor the sound before loading a track (page 57).
- Touch the title row to sort the list.
- Touch  on the title row to display the sub-column selection screen and select a sub-column to be displayed. To set sub-columns you want to display in the selection list (except for Beatport Streaming), go to **[Preferences]** in rekordbox.



6. **PREVIEW**

Displays or hides the **[PREVIEW]** column.

7. **Font size setting**

Sets the font size.

8. **Connection status icons**

-  (Internet connection icon): Displays the status of the internet connection.
-  (Wi-Fi connection icon): Displays the status of the Wi-Fi connection. Touch to display the Network category of the Utility settings.
-  (Bluetooth connection icon): Displays the status of the Bluetooth connection. Touch to display the Bluetooth category of the Utility settings.

9. **Rec timer**

Displays the recording time when using Master Rec (page 72). Touch to display the **[MIXER SETTINGS]** screen.

10. **(Information)**

Displays the detailed information for the loaded track.

11. **Deck display**



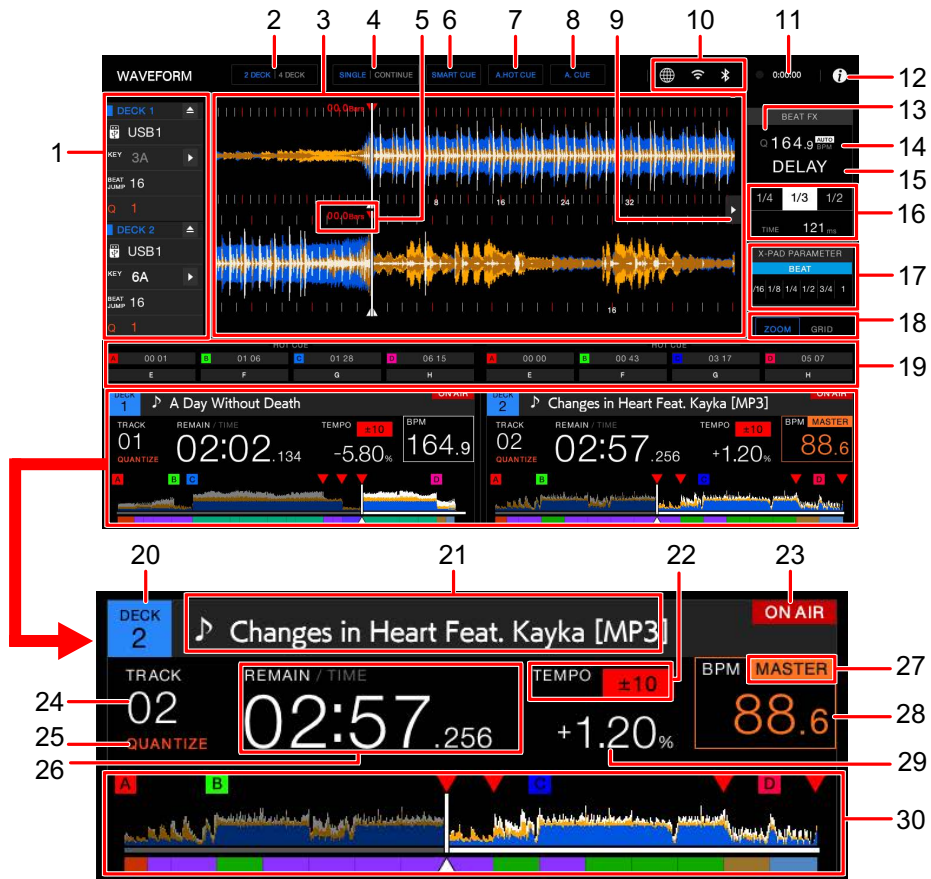

Playback screen (waveform screen)

❖ Main display



1. Deck information

Displays the following information for the deck and the loaded track.

- Deck number
- : Unloads the loaded track (you can't unload the track playing when [Eject/Load Lock] is set to [Lock] in the Utility settings (page 131). Set it to [Unlock] or press the  button to pause, then touch ).
- Device: Displays where the track is saved.
- Key: Displays the key of the track.
-  (Key Shift) (page 92)
- Number of beats for Beat Jump: Displays the number of beats set for a Beat Jump.
- Number of beats for a loop: Displays the number of beats set for a beat loop or a loop playing.

- Q indication and number of beats set for Quantize: Displays in red when Quantize for that deck is turned on and active, and in gray when it's turned on but not active (page 85).
2. **2 DECK/4 DECK**

Switches the deck display between 2 decks and 4 decks.
 3. **Enlarged waveform**

Displays the enlarged waveform, cue points, loop points, and Hot Cue points, etc. that have been analyzed by rekordbox.

 - You can change the waveform color in **[MY SETTINGS LOAD]** or **[Waveform Color]** on the **[SOURCE]** screen (page 34).
 4. **SINGLE/CONTINUE**



Switches the playback method between continuous play and single play for the loaded tracks.
 5. **Beat countdown**

Displays the number of bars and beats from the playback point to the closest saved cue point.
 6. **SMART CUE**

Turns on and off Smart Cue.
 7. **A. HOT CUE**

Turns on and off Auto Hot Cue (page 97).
 8. **A. CUE**

Turns on and off Auto Cue (page 78).
 9. **FX tab**

Displays or hides the Beat FX information panel.
 10. **Connection status icons**
 -  (Internet connection icon): Displays the status of the internet connection.
 -  (Wi-Fi connection icon): Displays the status of the Wi-Fi connection. Touch to display the Network category of the Utility settings.
 -  (Bluetooth connection icon): Displays the status of the Bluetooth connection. Touch to display the Bluetooth category of the Utility settings.
 11. **Rec timer**

Displays the recording time when using Master Rec (page 72). Touch to display the **[MIXER SETTINGS]** screen.
 12.  **(Information)**

Displays the detailed information for the loaded track.

13. **Q indication (Quantize for Beat FX)**

Displays in red when Quantize for Beat FX is turned on and active, and in gray when it's turned on but not active (page 121).

14. **BPM (for Beat FX)**

Displays BPM (beats per minute, i.e. tempo) for Beat FX.

- **[AUTO]** and the automatically detected BPM are displayed when in Automatic BPM Measuring mode,
- **[TAP]** and BPM (in green) are displayed when in Manual BPM Input mode.

15. **Beat FX**

Displays the selected Beat FX (effect name) (page 123).

16. **Parameter**

Displays the msec (milliseconds) and beat parameters set for the selected effect.

17. **X-Pad status**

Displays the operating position on the X-Pad.

18. **ZOOM/GRID**

Switches between Zoom and Grid Adjust modes.

- You can switch between Zoom and Grid Adjust modes by pressing and holding the rotary selector.
- Turn the rotary selector to control the following.
 - In Zoom mode: Zooms in and out of the upper and lower waveforms on the screen at the same time.
 - In Grid Adjust mode: Adjusts the beatgrid for the track loaded on the active deck (page 90).

19. **Pad mode status**

Displays the pad mode being used on the deck (page 93).

20. **Deck number**

21. **Track name**

Displays the track name for the loaded track.

22. **Playback speed**

Displays the playback speed set by the TEMPO slider.

23. **ON AIR indication**

Displayed when the sound from the **[MASTER 1]** or **[MASTER 2]** terminals can be output.

24. **Track number**

Displays the number (01-999) of the loaded track.

25. **QUANTIZE indication (for deck)**

Displayed in red when Quantize for that deck is turned on and active, and in gray when it's turned on but not active (page 85).

- Set the number of beats in [**Quantize Beat Value (Deck)**] in the Utility settings (page 131) or [**Quantize Beat Value**] on the [**SHORTCUT**] screen (page 146).

26. **Time display (minutes, seconds, msec)**

Displays remaining time or elapsed time.

Touch the time display to switch between remaining time and elapsed time.

- [**TIME**] of [**REMAIN/TIME**] is displayed in gray when remaining time is displayed and [**REMAIN**] of [**REMAIN/TIME**] is displayed in gray when elapsed time is displayed.

27. **MASTER indication**

Displayed when the deck is set as the sync master.

28. **BPM (for deck)**

Displays BPM (beats per minute, i.e. tempo) for the track playing.

- The measured value may differ from that measured by our DJ mixers due to differences in the measurement methods. This isn't a malfunction.

29. **Playback speed adjustment range**

Displays the adjustable range from the original playback speed (page 70).

30. **Overall waveform**

Displays the overall waveform, cue points, loop points, and Hot Cue points, etc. that have been analyzed by rekordbox or this unit.

- The indicators on the overall waveform indicate the following.
 - Playing address: Shows the track as a bar graph (horizontal line). The current playback point is indicated with a white vertical line on the bar graph. When the time display is set to [**TIME**], the graph lights up from the start of the track up to the playback point to indicate elapsed time. When the time display is set to [**REMAIN**], the graph goes dark to the left of the playback point, so the remaining part of the track stays lit up.
 - Scale display (30-second interval)/phrase: Displays scales at 30-second intervals or displays the phrase below the playing address. You can set the display (scale or phrase) in [**Waveform Divisions**] of the Utility settings or on the [**SHORTCUT**] screen (pages 138, 146).
 - Saved cue/loop points, Hot Cue/Loop points: Indicates cue/loop points and Hot Cue/Loop points saved in the track with marks above the waveform.
 - Cue/loop points: Indicates cue/loop points set in the track with marks below the waveform.

- Countdown display: Displays the saved cue point that's set as the countdown target.
- You can change the waveform color in [MY SETTINGS LOAD] or [Waveform Color] on the [SOURCE] screen (page 34).
- You can set different colors for saved cue/loop points and Hot Cue/Loop points in rekordbox.

Jog display

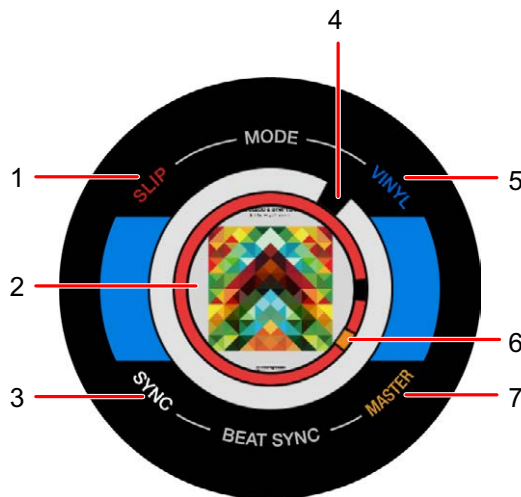

1. **SLIP indicator**
Lights up when Slip mode is turned on.
2. **Artwork/number of beats for loop/Pad mode display**
Displays artwork of the loaded track. You can set the artwork to display for each track in [Image On-Jog Display] in the Utility settings or on the [SHORTCUT] screen (pages 138, 146).
Displays the number of beats for the loop when a loop is playing.
Displays Pad mode being used on the deck in Pad mode. You can set the Pad mode display in [Pad Info Display] on the [SHORTCUT] screen (page 146).
3. **SYNC indicator**
Lights up when Beat Sync is turned on.
4. **Playback point indicator**
Indicates the playback point (turns during playback and stops when the track is paused).

5. **VINYL indicator**
Lights up when Vinyl mode is turned on.
6. **Cue/loop/Hot Cue point indicator**
Indicates cue points, loop points, or Hot Cue points.
7. **MASTER indicator**
Lights up when the deck is set as the sync master.

Basic operations on the touchscreen

Use the rotary selector or touch the screen to operate it.

❖ Using the rotary selector

The following functions are available.

Operation	Description
Rotate	Moves the cursor and highlights an item.
Press	Selects the highlighted item.

❖ Touch operations

The following functions are available.

Operation	Description
	Selects the highlighted item.
Touch	Other than waveform <ul style="list-style-type: none"> • Touch an item (e.g. a folder) in a hierarchy to display the next level down. • Touch a track to display the track menu.
	Waveform
Flick	Scrolls up or down in the hierarchy.

❖ Returning to the next level up

1 Press the **[BACK]** button on the top panel.

The next level up (previous screen) is displayed.

- Press and hold the **[BACK]** button to highlight the top level in the hierarchy.

Connections (basic styles)

Turn the unit off and disconnect the power cord before connecting other units.

Connect the power cord after all the connections are complete.

- Use the supplied power cord.
- Read the instruction manuals for the devices you are going to connect with the unit.

PRO DJ LINK

USB Export

You can transfer audio files and management data of rekordbox for use on this unit using a USB device (flash memory or hard disk). You can play playlists or tracks with cues, loops, and Hot Cues previously set in rekordbox.

- This unit only supports Device Library Plus (page 13).

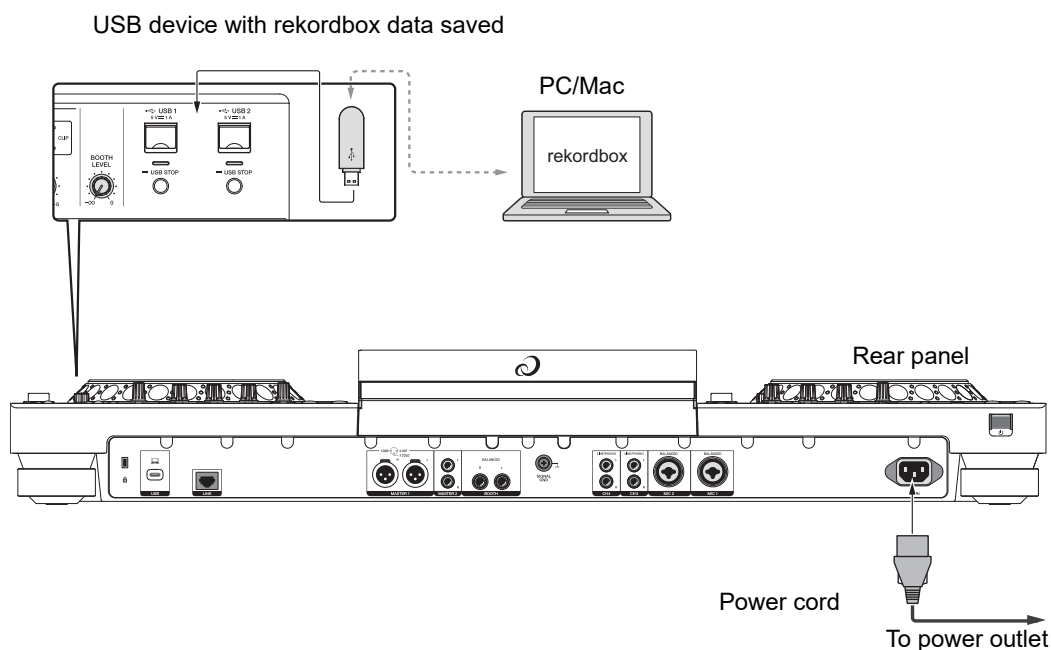

rekordbox Link Export

You can directly select and play tracks in rekordbox with this unit when the unit is connected via a LAN cable (CAT5e), a USB cable, or wireless LAN (Wi-Fi) to a PC/Mac or mobile device running rekordbox. You can play playlists or tracks with cues, loops, and Hot Cues previously set in rekordbox.

- Install the rekordbox for Windows USB connection (Link Export) driver software before connecting the unit to a PC with a USB cable (page 16).
- For information on the connection with rekordbox for iOS/Android, refer to the FAQ at the URL below.

iOS:

rekordbox.com/en/support/faq/connecting-to-dj-units/#faq-q100037

Android:

rekordbox.com/en/support/faq/connecting-to-dj-units-android/#faq-q110039

❖ When using a USB cable

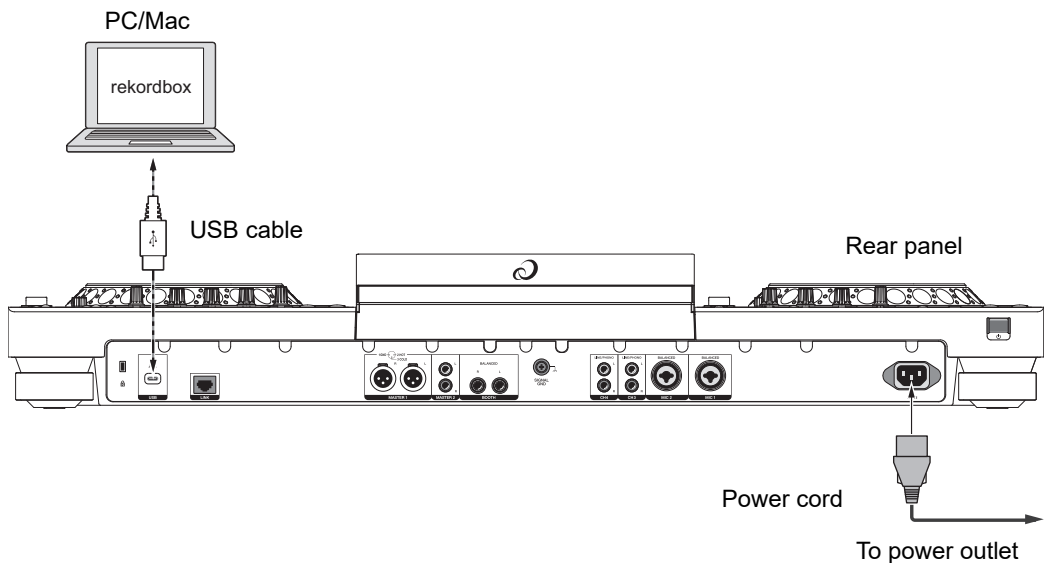

- Insert or pull a USB cable straight into/out of the USB port on the rear panel. Be careful not to apply force in a vertical or horizontal direction.

Connections (basic styles)

❖ When using a LAN cable

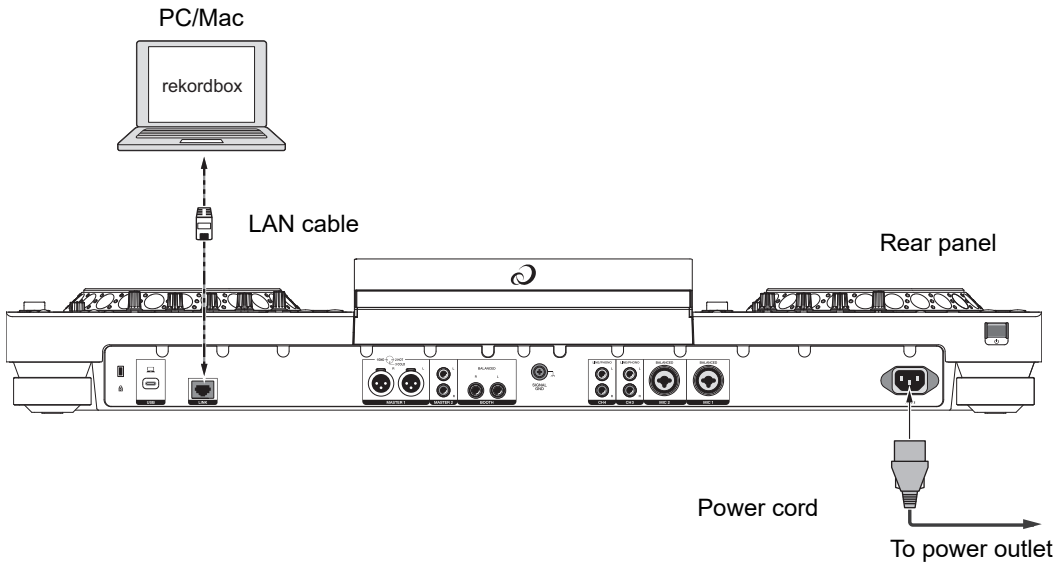

❖ When using a wireless LAN router and an access point

Using a LAN cable:

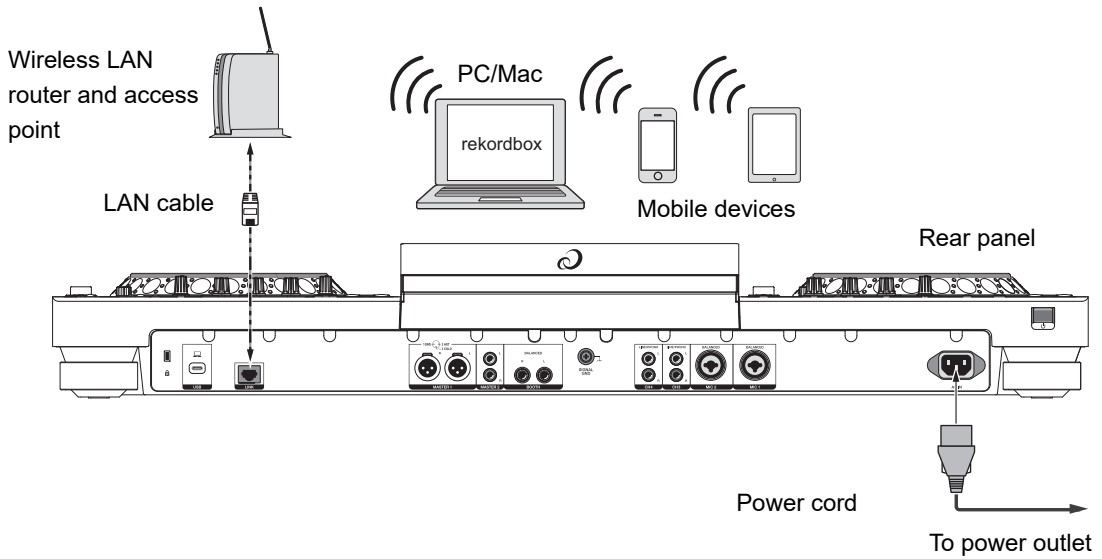

Connections (basic styles)

Using the internal wireless connection (Wi-Fi):

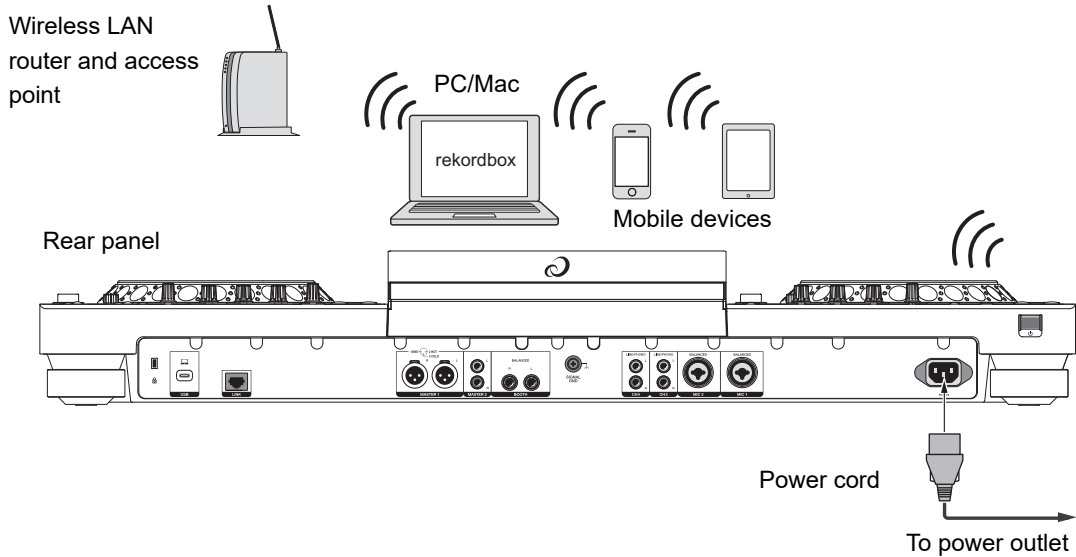

- While using the internal wireless connection (Wi-Fi) on the unit, you can't use rekordbox Link Export via a LAN cable (CAT5e) or a USB cable.

Connecting storage devices

USB section

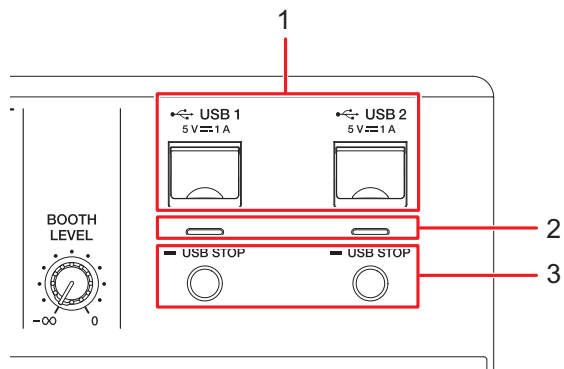

1. **USB 1, USB 2 ports**
2. **USB 1, USB 2 indicators**
Blinks while communicating with a USB device.
3. **USB 1, USB 2 STOP buttons**

USB device

- Do not disconnect a USB device from the unit without using the **[USB STOP]** button and do not turn the unit off when a USB device is connected, otherwise the unit's management data may be deleted or the USB device may become unreadable.
- Be careful not to press or pull the USB port cover with excessive force, or it may be damaged.
- Do not use an extension cable when connecting a USB device to the unit, or communication may be interrupted.

Connecting a USB device

- 1 Insert a USB device at a straight angle until it stops.**

Disconnecting a USB device

- 1 Press the [USB STOP] button until the USB indicator stops blinking.**
- 2 Pull the USB device out at a straight angle.**
 - If the tracks loaded to the deck from the removed USB device have been cached, the track aren't unloaded and playback continues with the restriction.

Track selection

Browse section

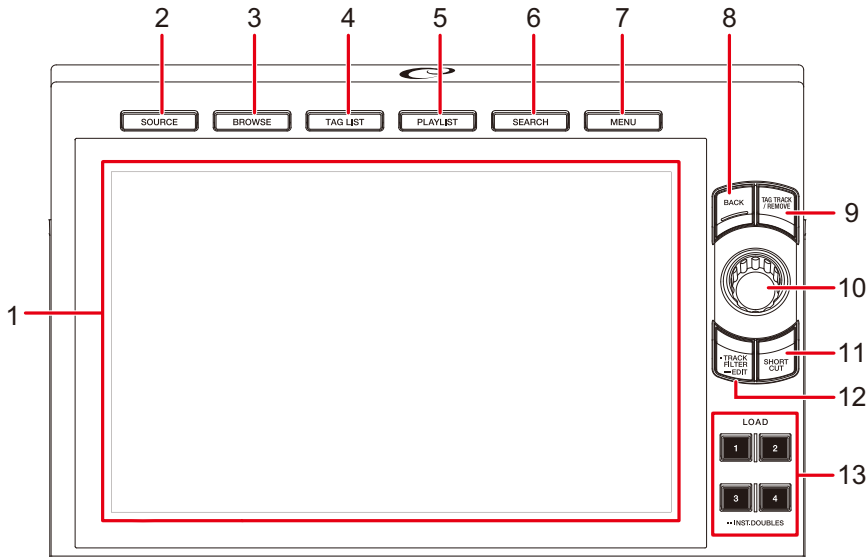

1. **Touchscreen** (page 34)
2. **SOURCE button**
Displays the [SOURCE] screen (page 34).
3. **BROWSE button**
Displays the [BROWSE] screen.
4. **TAG LIST button**
Displays the [TAG LIST] screen (page 60).
5. **PLAYLIST button**
Displays the Playlist screen (page 64).
6. **SEARCH button**
Displays the Search screen.
7. **MENU button**
Displays menu items for the current screen (the function being used) or the Utility settings (page 130).
8. **BACK button** (page 44)

9. TAG TRACK/REMOVE button

Adds tracks to, or deletes them from, the tag list (page 61).

10. Rotary selector (page 43)

11. SHORTCUT button (page 145)

12. TRACK FILTER/EDIT button

Narrows down tracks by tag information, BPM, or key, etc. set in rekordbox (page 55).

13. LOAD 1/2/3/4 buttons (page 57)

Selecting a source

1 Press the [SOURCE] button.

Devices connected to the unit are displayed on the [SOURCE] screen (page 34).

2 Select a device.

Selecting a track

Selecting a track on the browse screen

1 Open the browse screen.

A track list is displayed.

➡ Read more: Browse screen (page 36)

2 Select a track.

➡ Read more: Loading a track to a deck (page 57)

Searching for a track

Using the Search feature

This feature is only available when browsing the rekordbox library.

1 Press the [SEARCH] button.

The Search screen appears.

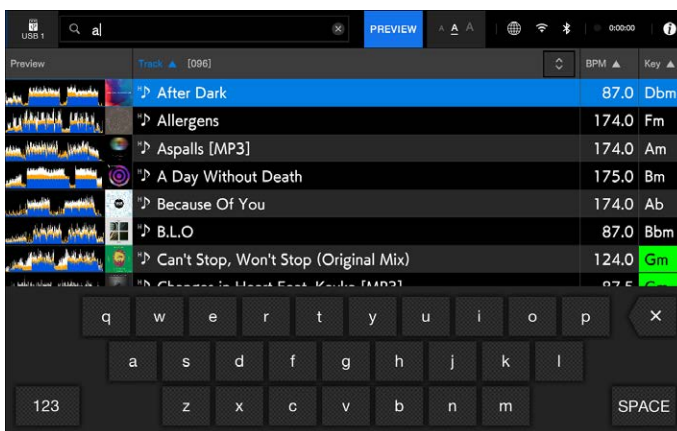

2 Enter a keyword using the keyboard.

Tracks including the keyword are displayed in the list.

- You can specify multiple keywords by separating them with a space.

Using the Jump feature

The unit supports 2 jump modes.

❖ Alphabet Jump

1 Press and hold the rotary selector when the alphabetical order list is displayed.

Alphabet Jump mode turns on, and the first character of the highlighted track or category is displayed on the screen.

- A to Z, 0 to 9, and some symbols are displayed in Alphabet Jump mode.

2 Turn the rotary selector to scroll the screen.

The cursor jumps to the track or category whose first character is the same as the displayed character.

- The cursor doesn't jump when there are no tracks or categories whose first character is the same as the displayed character.

❖ Page Jump

1 Press and hold the rotary selector when a list other than the alphabetical order list is displayed.

Page Jump mode turns on.

2 Turn the rotary selector to scroll the screen.

The cursor jumps to the first or last track in the list on each page.

Using Track Filter

You can narrow down tracks by BPM, key, or the tag information, etc added by rekordbox. This feature is only available when browsing the rekordbox library.

❖ Narrowing down tracks

1 Press the [TRACK FILTER/EDIT] button.

Tracks are narrowed down by the currently set conditions.

❖ Specifying the conditions on the Track Filter editing screen

1 Press and hold the [TRACK FILTER/EDIT] button.

The Track Filter editing screen appears.

2 Specify the filter conditions.

- You can choose BPM, key, rating, color, or the tag information added by rekordbox as filter conditions.
- Touch to add a check mark to enable the filter conditions.
- Touch [**MASTER DECK**] to read the BPM and key of the track playing on the deck set as the sync master.
- You can set the track filter conditions in rekordbox.
- The filter conditions are saved independently for each storage device.

Searching by key of the track playing

The key icons of tracks which are good matches with the key (related key) of the track loaded to the master deck are displayed in green.

- This function isn't available when no deck is set as the sync master.

Searching with Information Jump

You can search for tracks of the same genre or BPM as the track whose details are displayed on the touchscreen.

1 Touch **i** on the waveform screen.

➡ Read more: Playback screen (waveform screen) (page 38)

The [INFO] screen appears.

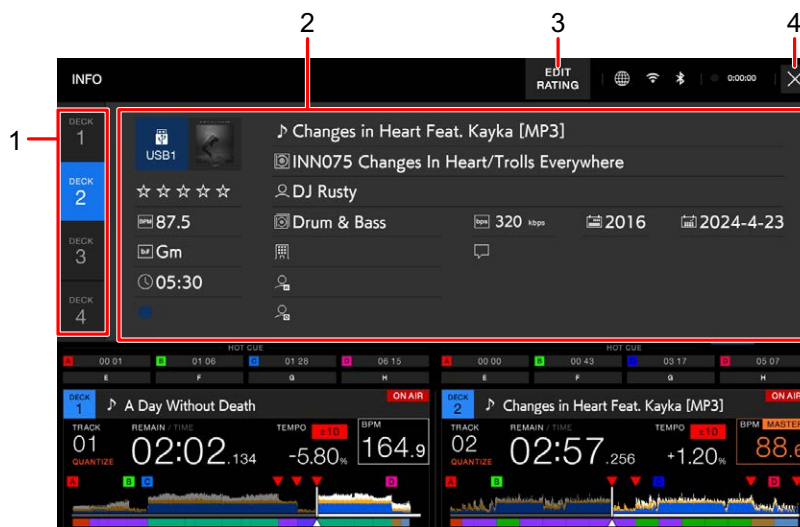

1. **Deck number:** Touch to switch the decks and display the information of the track loaded on the relevant deck.
2. **Detailed information of the track**
3. **EDIT RATING:** Touch to change your rating of the track.
4. **✕:** Touch to return to the waveform screen.

2 Select an item from the detailed information of the track.

Tracks included in the selected category are displayed on the browse screen.

- You may not be able to select items if any of the following conditions apply.
 - There are no categories.
 - Only icons are displayed in the detailed information of the track.

Monitoring sound before loading a track (Touch Preview)

You can monitor the sound of a track before loading the track.

1 Connect headphones to the unit.

➡ Read more: Front panel (page 32)

2 Press the [LINK CUE] button.

➡ Read more: Headphones section (page 108)

3 Touch the waveform displayed in the track list.

Monitor the sound from the touched point with your headphones.

- You can monitor the sound of a track while touching the waveform even when outputting the sound of a track that's playing on the unit.
- You can't monitor the sound of tracks which can't be loaded to the decks.

➡ Read more: Browse screen (page 36)

Loading a track to a deck

1 Select a track in the track list.

➡ Read more: Selecting a track (page 52)

2 Press the [LOAD 1/2/3/4] button.

The track is loaded to the corresponding deck.

- You can't load another track while a track is playing when [Eject/Load Lock] is set to [Lock] in the Utility settings (page 131). Set it to [Unlock], or press the [▶/||] button to pause playback, then load another track.
- When Auto Cue is turned on, playback is paused at the start of a track. Press the [▶/||] button to start playback.

Loading a track using the track menu

You can display the track menu by pressing the rotary selector when a track is selected on the Browse, Playlist, Search, or Tag List screen.

You can then load a track from the track menu.

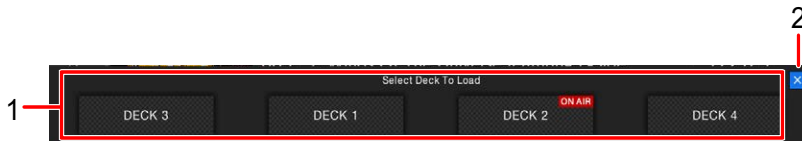

1. **DECK 1 to 4**
Loads a track to the deck and starts playback.
2. **✕ (Cancel)**
Closes the track menu.

Using History

Tracks played for approximately 1 minute are recorded in the History (playback list) (up to 999 tracks).

- A new History is automatically created on a storage device when it's connected to the unit.
- If you play a track more than once in succession, it may not be recorded in History.
- The information such as name of tracks recorded in History is displayed in green (indicates that the track has been played).
- You can create a playlist from the History using rekordbox. For details, refer to the rekordbox for Mac/Windows Instruction Manual (page 9).

Viewing History

1 Press the [BROWSE] button.

The [BROWSE] screen appears.

2 Select [HISTORY] in the category.

The History list is displayed.

Deleting History

1 Select a History you want to delete in the History list and press the [MENU] button.

The deletion menu appears.

2 Select [DELETE] or [ALL DELETE].

- [DELETE]: Deletes the selected History.
- [ALL DELETE]: Deletes all History lists.

- If you create a playlist from the History using rekordbox, the HISTORY is deleted from the storage device.

Using the Tag List

You can tag a track you want to play next or tracks you think will work well in your performance and review them via the Tag List.

- One Tag List is created for each storage device, CloudDirectPlay, or Beatport Streaming. A track can't be registered to multiple devices.
- Up to 100 tracks can be registered to the Tag List on each storage device.
- A track can't be registered to a Tag List more than once.

Tag list screen

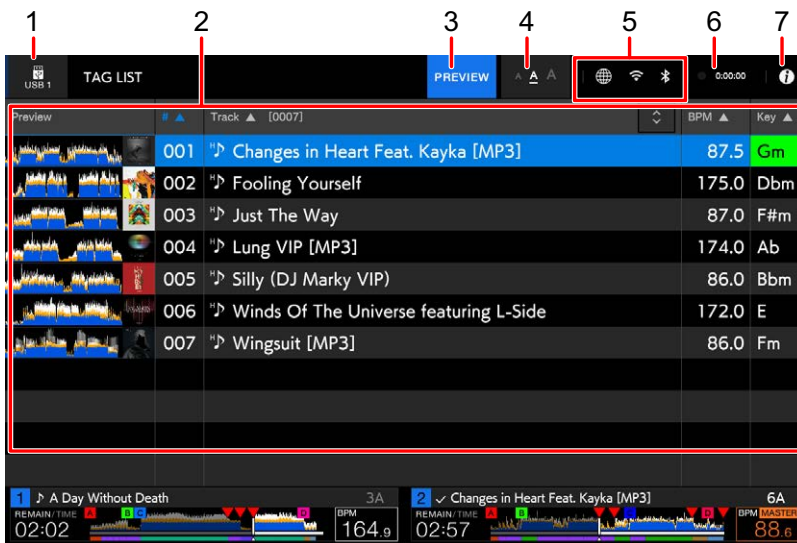

1. Device icon

Displays the icon of a device selected on the [SOURCE] screen (page 34).

2. Tag list

Displays the Preview waveform, artwork, serial number, and track list in the taglist.

- Touch the waveform in the [PREVIEW] column to monitor the sound before loading a track (page 57).
- Touch the title row to sort the list.
- Touch  on the title row to display the sub-column selection screen and select a sub-column to be displayed. To set sub-columns you want to display in the selection list (except for Beatport Streaming), go to [Preferences] in rekordbox.



3. **PREVIEW**

Displays or hides the **[PREVIEW]** column.

4. **Font size setting**

Sets the font size.

5. **Connection status icons**

-  (Internet connection icon): Displays the status of the internet connection.
-  (Wi-Fi connection icon): Displays the status of the Wi-Fi connection. Touch to display the Network category of the Utility settings.
-  (Bluetooth connection icon): Displays the status of the Bluetooth connection. Touch to display the Bluetooth category of the Utility settings.

6. **Rec timer**

Displays the recording time when using Master Rec (page 72). Touch to display the **[MIXER SETTINGS]** screen.

7. **(Information)**

Displays the detailed information for the loaded track.

Registering a track to the Tag List

1 **Highlight a track.**

- You can add tracks included in a folder or playlist to the Tag List instantly by selecting a folder or playlist.

2 **Press the **[TAG TRACK/REMOVE]** button.**

A check mark is displayed for the tracks registered to the Tag List.

- You can also register tracks loaded on the deck to the Tag List by pressing the **[TAG TRACK/REMOVE]** button on the **[INFO]** screen.

Deleting a track from the Tag List

❖ Deleting an individual track on the Tag List screen

- 1 Highlight a track.
- 2 Press and hold the [TAG TRACK/REMOVE] button.

The track is deleted from the Tag List.

❖ Deleting an individual track on the Browse, Playlist or Search screen

- 1 Highlight a track.
- 2 Press the [TAG TRACK/REMOVE] button.

The track is deleted from the Tag List.

❖ Deleting all tracks at once

- 1 Press the [TAG LIST] button.
- 2 Press the [MENU] button.
- 3 Select [REMOVE ALL TRACKS].

The [TAG LIST] screen appears.

[MENU] is displayed.

All tracks in the Tag List are deleted.

- If you delete a track from the Tag List while playing, the track continues to play until the end. The next track won't play.

Converting the Tag List to a playlist

A playlist converted from the Tag List is displayed in the **[PLAYLIST]** category.

- You can't convert the Tag List to a playlist if the rekordbox library isn't saved on the storage device or in CloudDirectPlay.
- If a mixture of tracks – some managed and some not managed by rekordbox – are registered in the Tag List, only the tracks managed by rekordbox are converted to a playlist.

1 Press the **[TAG LIST]** button.

The **[TAG LIST]** screen appears.

2 Press the **[MENU]** button.

[MENU] is displayed.

3 Select **[CREATE PLAYLIST]**.

The Tag List is converted to a playlist with the name **[TAG LIST XXX]**.

Displaying the playlist screen

Playlist screen

Press the **[PLAYLIST]** button to display the Playlist screen. You can also display the Playlist screen from the browse screen (page 36).



1. Playlist Bank

Displays the playlist when a playlist is registered to a Playlist Bank (page 66). With Playlist Banks, you can find a playlist without browsing the folder hierarchy.

2. Category

Displays the **[PLAYLIST]** category.

3. Device icon

Displays the icon of a device selected on the **[SOURCE]** screen (page 34).

4. ◀ (Back)

Displays the next level up.

5. Next level up display

Displays the name of a folder or device in the next level up.



6. PREVIEW

Displays or hides the **[PREVIEW]** column.

7. Font size setting

Sets the font size.

8. Connection status icons

-  (Internet connection icon): Displays the status of the internet connection.
-  (Wi-Fi connection icon): Displays the status of the Wi-Fi connection. Touch to display the Network category of the Utility settings.
-  (Bluetooth connection icon): Displays the status of the Bluetooth connection. Touch to display the Bluetooth category of the Utility settings.

9. Rec timer

Displays the recording time when using Master Rec (page 72). Touch to display the **[MIXER SETTINGS]** screen.

10. (Information)

Displays the detailed information for the loaded track.

11. Track list

Displays the Preview waveform, artwork, serial number, and the track list in the playlist.

- Touch the waveform in the **[PREVIEW]** column to monitor the sound before loading a track (page 57).
- Touch the title row to sort the list.
- Touch  on the title row to display the sub-column selection screen and select a sub-column to be displayed. To set sub-columns you want to display in the selection list (except for Beatport Streaming), go to **[Preferences]** in rekordbox.

❖ Changing the status of a track in a playlist to **PLAYED** or **UNPLAYED**

- You can also change the status of a track in other lists than a playlist in the same way.

1 Press the **[MENU]** button when a track in a playlist is selected.

[MENU] is displayed.

2 Select **[PLAYED]** or **[UNPLAYED]**.

- **[PLAYED]**: Sets unplayed tracks to “played”. Tracks set to “played” are displayed in green and registered to the History.
You can't select **[PLAYED]** when a played track is selected.
- **[UNPLAYED]**: Sets played tracks to “unplayed”. Tracks set to “unplayed” are displayed in white and deleted from the History.
You can't select **[UNPLAYED]** when an unplayed track is selected.

❖ Deleting a playlist

1 Press the [MENU] button on the [PLAYLIST] screen.

[MENU] is displayed.

2 Select [DELETE] or [ALL DELETE].

- [DELETE]: Deletes the selected playlist.
- [ALL DELETE]: Deletes all playlists.

Registering a playlist to a Playlist Bank

1 Highlight a playlist on the [PLAYLIST] screen.

2 Select a Playlist Bank whose icon is displayed in gray.

The playlist is registered to the Playlist Bank and the icon turns white.

- Select a Playlist Bank with a white icon to display tracks in the registered playlist.

Deregistering a playlist from a Playlist Bank

1 Select in the Playlist Bank.

Deregistration mode turns on and × is displayed alongside Playlist Bank icons.

2 Select the Playlist Bank to deregister the playlist from.

The playlist is deregistered and deregistration mode turns off.

Playback

Deck section

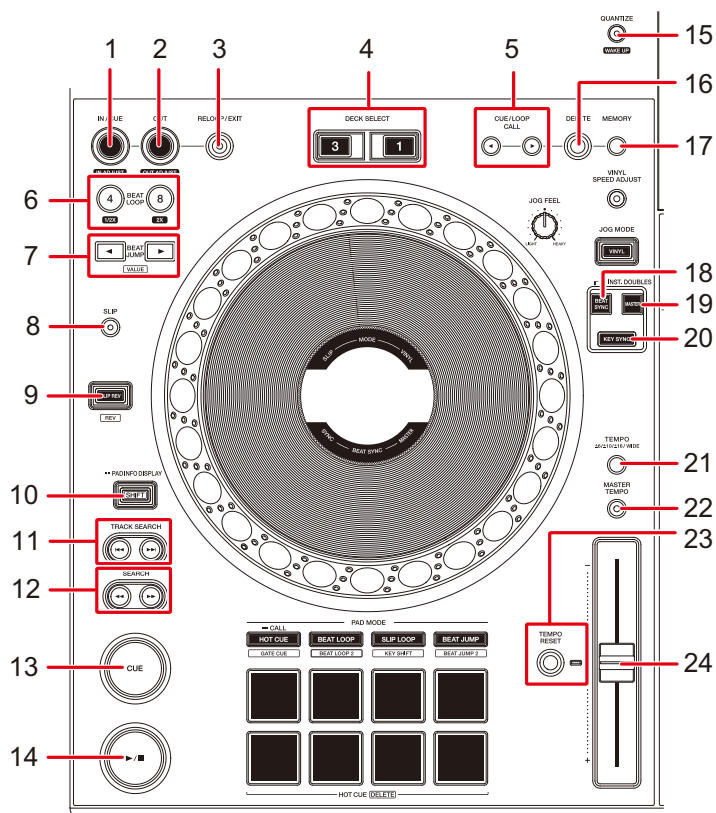

1. **IN/CUE (IN ADJUST) button** (pages 76, 79)
2. **OUT (OUT ADJUST) button** (pages 79, 80)
3. **RELOOP/EXIT button** (page 82)
4. **DECK SELECT buttons**
Selects the deck to use.
5. **CUE/LOOP CALL ◀, ▶ buttons** (pages 77, 81, 83)
6. **4 BEAT LOOP (1/2X), 8 BEAT LOOP (2X) buttons** (pages 80, 81)
7. **BEAT JUMP ◀, ▶ buttons** (page 84)
8. **SLIP button** (page 87)
9. **SLIP REV button** (page 69)
Lights up during reverse playback or Slip Reverse.

10. **SHIFT button**
11. **TRACK SEARCH |◀◀, ▶▶| buttons**
Jumps to the beginning of a track.
12. **SEARCH ◀◀, ▶▶ buttons**
Fast forward or fast reverse a track.
13. **CUE button** (page 76)
14. **▶/|| button**
Plays or pause a track.
15. **QUANTIZE (for deck) button** (page 85)
16. **DELETE button** (pages 78, 83)
17. **MEMORY button** (pages 77, 83)
18. **BEAT SYNC (INST.DOUBLES) button** (page 88)
19. **MASTER button** (page 88)
20. **KEY SYNC button** (page 91)
21. **TEMPO ±6/±10/±16/WIDE button**
Sets the variable range of the TEMPO slider.
22. **MASTER TEMPO button**
Turns Master Tempo on and off.
23. **TEMPO RESET button, Tempo Reset indicator**
Resets to the track's original speed regardless of the TEMPO slider's setting.
The Tempo Reset indicator lights up when Tempo Reset is turned on.
24. **TEMPO slider** (page 70)

Play/pause

1 Press the [▶/||] button.

- During pause: Starts playing the loaded track.
- During playback: Pauses the track.
- Playback of the next track doesn't automatically start when [Play Mode] is set to [Single] in the Utility settings (page 132).
- Pausing playback in Vinyl mode mutes the sound, and in Normal mode it will output the sound intermittently (page 74).

Playing a track from the touched point on the overall waveform

1 Touch the overall waveform during pause or while pressing the top of the jog wheel in Vinyl mode.

The loaded track plays from the touched point.

- You can quickly move the playback point by sliding your finger to the point you want on the overall waveform.

Reverse playback

❖ Slip Reverse

1 Press and hold the [SLIP REV] button.

The button lights up and the loaded track plays in reverse while normal playback continues in the background.

- When the button is released, playback starts from the exact point the track would have reached by then.

❖ Reverse

1 Press the [SLIP REV] button while pressing the [SHIFT] button.

The button lights up and the loaded track plays in reverse.

- Acceleration and deceleration of playback according to jog wheel rotation are also reversed.
- Maintaining reverse playback from one track to the next isn't possible.
- You may not be able to scratch if you perform Track Search or loop playback during reverse playback.

Basic operations during playback

Function	Description
Fast-forward/fast-reverse	Press the [SEARCH ►►] or [SEARCH ◀◀] button to fast-forward or fast-reverse.
Track Search	Press the [TRACK SEARCH ►►] button to jump to the beginning of the next track. Press the [TRACK SEARCH ◀◀] button to jump to the beginning of the track that's playing. Press the button twice to jump to the beginning of the previous track.
Frame Search	Press the [SEARCH ►►] or [SEARCH ◀◀] button during pause to move the pause position.

Adjusting the playback speed (tempo control)

1 Move the TEMPO slider.

- To the [+] side: Increases the playback speed.
 - To the [-] side: Decreases the playback speed.
- The variable range of the TEMPO slider changes in the order of ± 6 (0.02%) \rightarrow ± 10 (0.05%) \rightarrow ± 16 (0.05%) \rightarrow WIDE (0.5%) each time you press the [**TEMPO $\pm 6/\pm 10/\pm 16$ /WIDE**] button*.
- The adjustable range of [**WIDE**] is $\pm 100\%$. The track stops when it's set to -100%.
- * The value in parentheses indicates the adjustment unit.

Adjusting the playback speed without changing the pitch (Master Tempo)

If you turn Master Tempo on, you can change the playback speed of a track using the TEMPO slider without changing the pitch.

1 Press the [MASTER TEMPO] button to turn Master Tempo on.

The button lights up when Master Tempo is turned on.

- Press the [MASTER TEMPO] button again to turn Master Tempo off.

Monitoring a different part of a track during playback (Touch Cue)

If you touch the overall waveform while a track is playing, you can monitor the sound from the touched point without affecting the output sound.

1 Connect headphones to the unit.

➡ Read more: Front panel (page 32)

2 Press the [LINK CUE] button.

➡ Read more: Headphones section (page 108)

3 Touch the overall waveform on the waveform screen.

You can monitor the sound from the touched position with your headphones.

- The waveform of the touched point is zoomed in on and displayed as an enlarged waveform.

Recording

You can record the same audio as the output from the **[MASTER 1]** and **[MASTER 2]** terminals into a WAV file on a USB device.

- The recorded file name will be “REC***.WAV” (*** is a 3-digit number).
- Because this unit doesn’t have a clock, the recording time and date aren’t registered on the USB device.

1 Insert a USB device to a USB port on the unit.

➡ Read more: USB section (page 49)

2 Press the **[MIXER SETTINGS]** button.

The **[MIXER SETTINGS]** screen appears.

3 Select the USB device and touch **[Rec]**.

Recording starts.

- Recording isn’t available when **[Bluetooth]** is selected with the input selector.
- You can record for approximately 90 minutes on a USB device with 1GB of free space.
- Touch **[Rec]** again to end recording. Recording stops and the button light turns off.

Splitting a track during recording

1 Press the **[MIXER SETTINGS]** button.

The **[MIXER SETTINGS]** screen appears.

2 Touch **[Track Mark]** during recording.

The file is split at the point where **[Track Mark]** is touched, and the recording continues as a new file from the split point.

Setting the jog wheel mode

1 Press the [VINYL (JOG MODE)] button.

Each press switches between the following modes. The button lights up in Vinyl mode.

- **Vinyl mode:** Stops playback with a press on the top of the jog wheel and scratches a track by turning the jog wheel while pressing the top.
- **Normal mode:** Doesn't stop playback or scratch a track with the operations of the jog wheel.

Jog wheel operations

You can use the following features in combination with the jog wheel.

Function	Description
Pitch Bend	<p>Turn the outer section of the jog wheel clockwise during playback to increase the playback speed, and counterclockwise to decrease it. Stop turning it to resume the normal playback speed.</p> <ul style="list-style-type: none"> • In Normal mode, you can perform the same operations by turning the jog wheel while pressing the top.
Scratch	<p>Turn the jog wheel while pressing the top during playback in Vinyl mode to scratch a track.</p> <p>Release the jog wheel to resume normal playback.</p>
Frame Search	<p>Turn the jog wheel during pause to move the pause position.</p> <ul style="list-style-type: none"> • One full rotation moves the position by 1.8 seconds.
Super Fast Search	<p>Turn the jog wheel while pressing the [SEARCH ►►], [SEARCH ◀◀] or [SHIFT] button to fast-forward or fast-reverse with extra speed.</p>
Super Fast Track Search	<p>Turn the jog wheel while pressing the [TRACK SEARCH ►►] or [TRACK SEARCH ◀◀] button to cycle through tracks with extra speed according to the rotation direction.</p>

Adjusting the “weight” of the jog wheel

1 Turn the [JOG FEEL] knob.

- Turn clockwise: Increases the weight.
- Turn counterclockwise: Decreases the weight.

Adjusting the playback starting and stopping speeds (for Vinyl mode)

You can adjust the following speeds.

- The speed at which playback slows down and stops after the top of the jog wheel is pressed or the [▶/||] button is pressed
- The speed at which normal playback resumes after the top of the jog wheel is released or the [▶/||] button is pressed

1 Press the [SHORTCUT] button.

The [SHORTCUT] screen appears.

2 Select an adjustment setting in [Vinyl Speed Adjust].

- [Touch]: Adjusts the speed at which playback slows down and stops.
- [Release]: Adjusts the speed at which normal playback resumes.
- [Touch&Release]: Adjusts the speed at which playback slows down and stops, and normal playback resumes.

3 Adjust the speed in [Vinyl Speed Adjust Time].

4 Press the [VINYL SPEED ADJUST] button.

The [VINYL SPEED ADJUST] setting is enabled.

Cueing

You can quickly call up a cue point you have set previously.

Setting a cue point

❖ During pause

1 Press the [CUE] button.

A cue point is set.

- Press the [SEARCH ◀◀] or [SEARCH ▶▶] button or turn the jog wheel during pause to fine-adjust (0.5 frame unit) the pause position.

❖ During playback

1 Press the [IN/CUE (IN ADJUST)] button.

A cue point is set.

- If you set a new cue point, the previously set cue point is cleared.
- When [On] is set for [Overwrite Current Cue with Hot Cue (Smart Cue)] in the Utility settings, if you set a Hot Cue or start playback from a Hot Cue, the point is set as a cue point (page 131).

Jumping to a cue point

1 Press the [CUE] button during playback.

The track jumps to the cue point and cue standby mode turns on.

- If a comment has been set to the cue point, the comment is displayed in the track name display.

Checking a cue point (Cue Point Sampler)

1 Jump to a cue point.

➡ Read more: Jumping to a cue point (page 76)

2 Press and hold the [CUE] button.

Playback continues while pressing the [CUE] button.

- Press the [▶/||] button to continue playback even if you release the [CUE] button.

Saving a cue point

1 Set a cue point.

➡ Read more: Setting a cue point (page 76)

2 Press the [MEMORY] button.

Calling up a saved cue point

1 Load a track you have previously saved a cue point for.

2 Press the [CUE/LOOP CALL ◀] or [CUE/LOOP CALL ▶] button.

- If a comment has been set to the called up point in rekordbox, the comment is displayed in the track name display.

Deleting a saved cue point

1 Call up a saved cue point.

- ➡ Read more: Calling up a saved cue point (page 77)

2 Press the [DELETE] button.

Setting Auto Cue

When loading a track or performing Track Search, a cue point can be automatically set to the position immediately before the first sound in the track (skipping any silence at the beginning).

1 Touch [A. CUE] on the waveform screen to turn Auto Cue on.

- The Auto Cue setting is retained even if you turn the unit off.
- You can set the sound pressure level that you want to be recognized as silence in [**Auto Cue Level**] in the Utility settings (page 132).

Looping

You can choose a section of a track to play repeatedly.

Setting a loop

Manual setting

- 1 While the track is playing, press the **[IN/CUE (IN ADJUST)]** button at the point where you want to start the loop (loop-in point).
- 2 Press the **[OUT (OUT ADJUST)]** button at the point where you want the loop to end (loop-out point).

The chosen section plays in a loop.

Automatic setting

❖ Using 4 Beat Loop

- 1 Press and hold the **[IN/CUE (IN ADJUST)]** button during playback.

The track plays a 4-Beat Loop according to the BPM from the point where you pressed the button.

- If BPM can't be detected, it's set to 120.

❖ Using the 4 BEAT LOOP (1/2X) button

1 Press the [4 BEAT LOOP (1/2X)] button during playback.

The track plays a 4-Beat Loop according to the BPM from the point where you pressed the button.

- If the BPM can't be detected, it's set to 120.

❖ Using the 8 BEAT LOOP (2X) button

1 Press the [8 BEAT LOOP (2X)] button.

The track plays a 8-Beat Loop according to the BPM from the point where you pressed the button.

- If the BPM can't be detected, it's set to 120.

Fine-adjusting loop points

1 Press the [IN/CUE (IN ADJUST)] or [OUT (OUT ADJUST)] button during loop playback.

The unit switches to loop adjusting mode.

- [IN/CUE (IN ADJUST)]: Adjusts the loop-in point.
- [OUT (OUT ADJUST)]: Adjusts the loop-out point.

2 Turn the jog wheel to fine-adjust the loop point.

- Press the [IN/CUE (IN ADJUST)] or [OUT (OUT ADJUST)] button again, or leave the unit without operating the controls for more than 10 seconds to cancel loop adjusting mode.

Adjusting the length of a loop

Halving the length of a loop

- 1 Press the **[4 BEAT LOOP (1/2X)]** or **[CUE/LOOP CALL ◀]** button during loop playback.

The loop length is halved.

Doubling a loop in length

- 1 Press the **[8 BEAT LOOP (2X)]** or **[CUE/LOOP CALL ▶]** button during loop playback.

The loop length is doubled.

Returning to a loop-in point to start loop playback (Retrigger)

- 1 Press the **[IN/CUE (IN ADJUST)]** button while pressing the **[SHIFT]** button during loop playback.

The playback point returns to the loop-in point and starts loop playback from there.

Using Active Loop

Set a saved loop as an Active Loop using rekordbox beforehand.

1 Load a track that has an Active Loop set.

After the playback point passes the set point, loop playback automatically starts.

Canceling loop playback

1 Press the [RELOOP/EXIT] button during loop playback.

Loop playback is canceled.

- Press the [RELOOP/EXIT] button again to start loop playback from the loop-in point.

Emergency Loop

The unit automatically plays a Beat Loop if it can't start playing the next track when the end of the current track is reached. This prevents situations where your performance is interrupted by silence.

- You can't DJ during Emergency Loop playback.
- Load a track to cancel the Emergency Loop.
- When the file has been cached, Emergency Loop isn't applied and playback continues with the restriction.

Saving a loop

1 Set loop points.

➡ Read more: Setting a loop (page 79)

2 Press the **[MEMORY]** button.

Calling up a saved loop

1 Load a track you have previously saved a loop for.

2 Press the **[CUE/LOOP CALL ◀]** or **[CUE/LOOP CALL ▶]** button.

- If a comment is set to the called up point in rekordbox, the comment is displayed in the track name display.

Deleting a saved loop

1 Call up a saved loop.

➡ Read more: Calling up a saved loop (page 83)

2 Press the **[DELETE]** button.

- If you delete a loop set as an Active Loop, the Active Loop is also deleted (page 82).

Beat Jump/Loop Move

You can instantly move the playback point without changing the rhythm of a track that's playing.

Using Beat Jump/Loop Move

1 Press the **[BEAT JUMP ◀]** or **[BEAT JUMP ▶]** button during playback.

The playback point jumps by the number of beats from the point where the button is pressed.

- If you do this during loop playback, a loop is moved by the number of beats.
- To change the number of beats, press the **[BEAT JUMP ◀]** or **[BEAT JUMP ▶]** button while pressing the **[SHIFT]** button.

Quantize (for deck)

Cue points, loop-in points, loop-out points, and Hot Cue points are automatically set to the closest beat position even if your timing is off the beat when you set them.

You can use Hot Cues, loop, reverse playback, and Slip without breaking the rhythm of the track you are playing.

- You can't use the Quantize feature with tracks that haven't been analyzed by rekordbox or this unit. For details on track analysis by rekordbox, see the rekordbox Instruction Manual (page 9).
- You can set **[Quantize Beat Value (Deck)]** in the Utility settings (page 131) or **[Quantize Beat Value]** on the **[SHORTCUT]** screen (page 146).

Using Quantize

1 Press the **[QUANTIZE]** button.

Quantize turns on, then **[Q]** and the number of beats for Quantize are displayed on the deck information display on the waveform screen and **[QUANTIZE]** is displayed under the track number (page 38).

- Press the **[QUANTIZE]** button while pressing the **[SHIFT]** button to turn on and off Quantize on the deck whose **[SHIFT]** button is being pressed.
- Press the **[QUANTIZE]** button again to turn Quantize off.

Slip

If you turn Slip mode on, normal playback continues in the background (but you can't hear it) when you perform the following operations.

When you end the operation, Slip is canceled and normal playback starts from the exact point the track would have reached by then. This means the original rhythm remains constant and your performance stays perfectly in time.

Function	Description
Slip Pause	If you press the [▶/] button during playback in Vinyl mode (page 74), playback continues in the background during the pause.
Slip Scratch	If you scratch a track using the jog wheel while in Vinyl mode (page 74), normal playback continues in the background while you are scratching.
Slip Loop	If you start loop playback (page 79), normal playback continues in the background while the loop is playing.
Slip Reverse	If you press the [SLIP REV] button during playback, playback is reversed. Normal playback continues in the background during reverse playback.
Slip Hot Cue/Loop	If you press a Performance Pad with a Hot Cue/Loop set during playback, the playback point jumps to the Hot Cue/Loop point and playback continues until you release the button. Normal playback continues in the background during Hot Cue/Loop playback.

Turning Slip mode on

1 Press the [SLIP] button.

Slip mode turns on and the [SLIP] button lights up.

- The [SLIP] button blinks while Slip is in use.
- The current playback point in Slip mode is indicated by a yellow line on the overall and enlarged waveforms on the waveform screen.
The background playback point is indicated by a white line on the overall waveform on the waveform screen.
- Press the [SLIP] button again or load a track to turn off Slip mode.

Beat Sync

If you turn Beat Sync on, tempo (BPM) and beat position of tracks on the unit automatically synchronize.

- Beat Sync can't be used with tracks that haven't been analyzed by rekordbox.
- Tempo (BPM) and beat position of tracks on the unit can automatically synchronize with a DJ player (sync master) connected in the PRO DJ LINK network.
- You can set rekordbox for Mac/Windows as the sync master. For details, see the rekordbox Instruction Manual (page 9).

Using Beat Sync

1 Play a track analyzed by rekordbox or this unit on the deck you want to set as the sync master.

- You can set either deck as the sync master by pressing the **[MASTER]** button on the deck.

2 Play a track analyzed by rekordbox or this unit on the deck you want to sync with the sync master.

3 Press the **[BEAT SYNC (INST.DOUBLES)] button on the deck you want to sync with the sync master.**

Beat Sync turns on.

- Press the **[BEAT SYNC (INST.DOUBLES)]** button again to turn Beat Sync off. If the position of the TEMPO slider doesn't match the playback tempo (BPM), the Beat Sync tempo is maintained. To restore normal use of the TEMPO slider, load the track again or move the slider until the BPM matches the playback tempo. After this, you'll be able to use the TEMPO slider to adjust the tempo.

Using Instant Doubles

You can duplicate a track loaded on the active deck of DECK 1/3 or DECK 2/4 or a DJ player (sync master) connected in the PRO DJ LINK network so it plays on the other deck from exactly the same point.

1 Press the **[LOAD]** button twice on the deck where you want the duplicate track to start playing.

- You can also start Instant Doubles by pressing and holding the **[BEAT SYNC (INST.DOUBLES)]** button on the deck where you want the duplicate track to start playing.

Beatgrid

You can adjust the beatgrid.

- You can't adjust the beatgrid for tracks that haven't been analyzed by rekordbox or this unit.

Adjusting the beatgrid

1 Press and hold the rotary selector on the waveform screen or touch **[ZOOM]/[GRID]** on the screen.

Grid Adjust mode turns on.

2 Turn the rotary selector to adjust the beatgrid.

- You can adjust the beatgrid on the active deck.
- You can also adjust the beatgrid using the following buttons on the screen.
 - **[SNAP GRID(CUE)]**: Moves the first beat position to a cue point.
 - **[SHIFT GRID]**: Applies the settings (Pitch Bend, etc.) adjusted during synchronization.
 - **[<1/2], [1/2>]**: Moves the beatgrid by 1/2 beat.
- Touch **[RESET]** to reset to the original beatgrid.
- To return to Zoom mode, press and hold the rotary selector on the waveform screen again or touch **[ZOOM]/[GRID]** on the screen.
- Press the **[DECK SELECT]** buttons to switch between decks.

Key Sync

You can adjust the key of a track playing on the unit to match with the key of a track loaded on the sync master.

- You can't adjust the key for tracks that haven't been analyzed by rekordbox.

Using Key Sync

1 Press the [KEY SYNC] button when a track is loaded.

The key is adjusted to the key with the least change among the following.

- Same key
 - Dominant key
 - Subdominant key
 - Relative key
 - Relative key of dominant key
 - Relative key of subdominant key
- Press the [KEY SYNC] or [MASTER TEMPO] button to reset to the original key.

Key Shift

You can shift the key of a track.

Using Key Shift

- 1 Touch  of the key display on the waveform screen.

The Key Shift screen appears.

- 2 Touch [-] or [+] to adjust the key.

Each touch shifts the key up or down by a semitone.



- Touch [RESET] to revert to the original key.

Using the Performance Pads

You can trigger various functions with the Performance Pads.

Performance Pads section

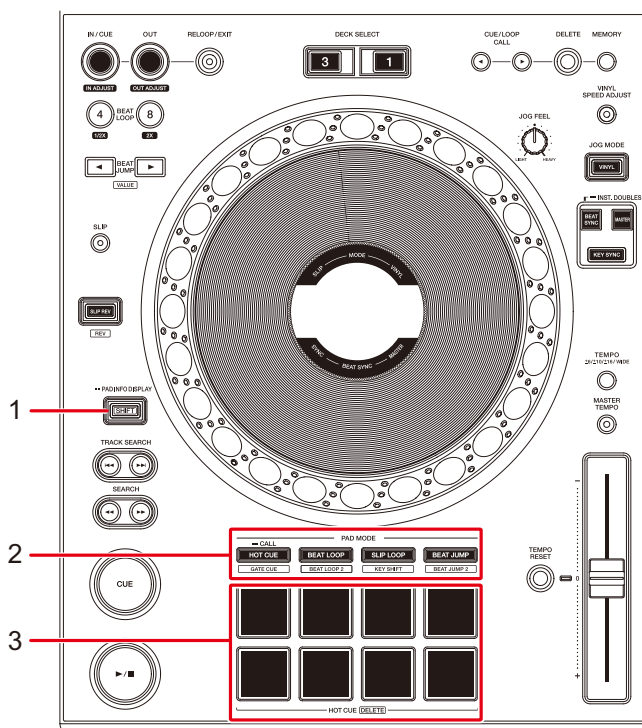

1. **SHIFT button**
2. **PAD MODE buttons**
 - **HOT CUE/CALL (GATE CUE) button:** Switches to Hot Cue mode or Gate Cue mode.
 - **BEAT LOOP (BEAT LOOP 2) button:** Switches to Beat Loop mode.
 - **SLIP LOOP (KEY SHIFT) button:** Switches to Slip Loop mode or Key Shift mode.
 - **BEAT JUMP (BEAT JUMP 2) button:** Switches to Beat Jump mode.
3. **Performance Pads**

Hot Cue/Gate Cue

You can call up a Hot Cue quickly and start playback by pressing a Performance Pad.

Setting a Hot Cue

1 Press the [HOT CUE/CALL (GATE CUE)] button.

The unit switches to Hot Cue mode.

2 Press a Performance Pad at the point where you want to set a Hot Cue during playback or pause.

A Hot Cue is set.

- You can set up to 8 Hot Cues per track.
- Hot Cues are assigned to the Performance Pads as follows.

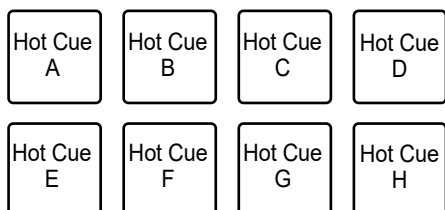

- If you do this during loop playback, a loop is set instead.
- When [On] is set for [Overwrite Current Cue with Hot Cue (Smart Cue)] in the Utility settings, the point is set as a cue point (page 131).
- You can't set a Hot Cue to any Performance Pads that have a one set already. To set a new Hot Cue, delete a one from a pad first (page 96).

Using the Performance Pads

- Performance Pads light up as follows according to the set function. You can change the colors using rekordbox.

Set function	[Hot Cue Color] setting in the Utility settings	
	[Off]	[On]
Cue point	Green	Fixed button color
Loop	Orange	Orange
No setting	No light	No light

Starting playback from a Hot Cue point

1 Press the [HOT CUE/CALL (GATE CUE)] button.

The unit switches to Hot Cue mode.

2 Press a Performance Pad that has a Hot Cue set during playback or pause.

Playback starts from the Hot Cue point.

- If you do this when a loop is set, loop playback starts (page 79).
- When [On] is set for [Overwrite Current Cue with Hot Cue (Smart Cue)] in the Utility settings, the point is set as a cue point (page 131).

Starting Gate playback from a Hot Cue point

- 1 Press the [HOT CUE/CALL (GATE CUE)] button in Hot Cue mode.**

The unit switches to Gate Cue mode.

- Press the [HOT CUE/CALL (GATE CUE)] button while pressing the [SHIFT] button in other mode than Hot Cue mode to switch to Gate Cue mode.

- 2 Press and hold a Performance Pad that has a Hot Cue set during pause.**

Playback starts from the Hot Cue point and continues until you release the Performance Pad.

- If you do this when a loop is set, loop playback starts (page 79).
- Press the [▶/||] button during Gate playback to continue playback even if you release the Performance Pad.

Deleting a Hot Cue

- 1 Press the [HOT CUE/CALL (GATE CUE)] button.**

The unit switches to Hot Cue mode.

- 2 Press a Performance Pad while pressing the [SHIFT] button.**

The Hot Cue set to the pad is deleted.

Calling up Hot Cues

❖ Automatic call-up

You can automatically call up Hot Cues saved on a storage device when a track is loaded.

1 Touch **[A. HOT CUE]** on the waveform screen to turn Auto Hot Cue on.

- **[ON]:** Displays “H)” for all tracks and automatically calls up Hot Cues from all tracks when loading them.
- **[OFF]:** Hot Cues aren’t automatically called up when loading a track.
- You can turn Auto Hot Cue on with **[Hot Cue Auto Load]** in the Utility settings (page 131).

❖ Manual call-up

You can call up a Hot Cue manually when **[Hot Cue Auto Load]** is set to **[Off]** and the conditions for the automatic call-up aren’t met.

1 Press the **[HOT CUE/CALL (GATE CUE)]** button.

The unit switches to Hot Cue mode.

2 Press and hold the **[HOT CUE/CALL (GATE CUE)]** button.

Performance Pads that have a Hot Cue set will blink.

3 Press a Performance Pad.

The set Hot Cue is called up.

- The Hot Cue call-up mode turns off in the following conditions.
 - All Hot Cues are called up.
 - The **[HOT CUE/CALL (GATE CUE)]** button is pressed.
 - The loaded track is replaced by another one.

Using a Hot Cue Bank

You can set Hot Cues to the **[HOT CUE]** (A to H) buttons on the unit using a Hot Cue Bank set with rekordbox for Mac/Windows.

- Hot Cue Banks can't be edited via the unit. You will need to use rekordbox for editing. For details, see the rekordbox Instruction Manual, available at the URL below.

rekordbox.com/manual

1 Press the **[BROWSE]** button.

The **[BROWSE]** screen appears.

2 Select **[HOT CUE]** in the category.

The Hot Cue Bank list is displayed.

3 Select a Hot Cue Bank.

Hot Cues registered in the selected Hot Cue Bank are displayed.

4 Touch a track in the Hot Cue Bank, or select a track then press the rotary selector.

Hot Cues registered in the Hot Cue Bank are set to the specified deck.

Beat Loop

If you press a Performance Pad, a loop is set with the number of beats or bars assigned to the Performance Pad.

Using Beat Loop

1 Press the [BEAT LOOP (BEAT LOOP 2)] button.

The unit switches to Beat Loop mode.

- Press the [BEAT LOOP (BEAT LOOP 2)] button while in Beat Loop mode to switch between Beat Loop mode and Beat Loop 2 mode.
- Press the [BEAT LOOP (BEAT LOOP 2)] button while pressing the [SHIFT] button while in any mode other than Beat Loop mode to switch to Beat Loop 2 mode.

2 Press a Performance Pad.

Loop playback starts according to the BPM of the track and the number of beats or bars assigned to the Performance Pad. The Performance Pad blinks during loop playback.

- The number of beats or bars for Beat Loop is assigned to the Performance Pads as follows.

Beat Loop mode:

1/4	1/2	1	2
4	8	16	32

- Beat Loop 2 mode:

3/4	1	3/2	3
5	6	7	9

Using the Performance Pads

- Press the blinking Performance Pad or press the [RELOOP/EXIT] button to cancel loop playback.
- If the BPM can't be detected, it's set to 120.

Slip Loop

Slip loop playback continues while pressing a Performance Pad regardless of whether Slip is turned on or off.

Using Slip Loop

1 Press the [SLIP LOOP (KEYSHIFT)] button.

The unit switches to Slip Loop mode.

2 Press a Performance Pad.

Loop playback starts according to the BPM of the track and the number of beats or bars assigned to the Performance Pad, and continues until you release the Performance Pad.

- The number of beats or bars for Slip Loop is assigned to the Performance Pads as follows.

1/16	1/8	1/4	1/2
1	2	1/3	3/4

- Normal playback continues in the background while the Slip Loop is playing.
- Release the Performance Pad to cancel Slip Loop playback. Normal playback starts from the exact point the track would have reached by then.
- If the BPM can't be detected, it's set to 120.

Key Shift

You can adjust the key of a track by pressing the Performance Pads.

Using Key Shift

1 Press the [SLIP LOOP (KEYSHIFT)] button in Slip Loop mode.

The unit switches to Key Shift mode.

- Press the [SLIP LOOP (KEYSHIFT)] button while pressing the [SHIFT] button while in any mode other than Slip Loop mode to switch to Key Shift mode.

2 Press a Performance Pad.

You can adjust the key by pressing the Performance Pads.

- Key Shifts are assigned to the Performance Pads as follows.

Key Sync	Semitone Up	+7	+12
Key Reset	Semitone Down	-5	-12

- **[Key Sync]**: Adjusts the key of track playing to match with the key of the track loaded on the master player.
- **[Semitone Up/Semitone Down]**: Changes the key by a semitone.
- **[+7/+12/-5/-12]**: Shifts the key from the original key by the specified shift amount.
- **[Key Reset]**: Resets the key shift to the original key.

Beat Jump/Loop Move

You can instantly move the playback point without changing the rhythm of a track that's playing.

Using Beat Jump/Loop Move

1 Press the [BEAT JUMP (BEAT JUMP 2)] button.

The unit switches to Beat Jump mode.

- Press the [BEAT JUMP (BEAT JUMP 2)] button while in Beat Jump mode to switch between Beat Jump mode and Beat Jump 2 mode.
- Press the [BEAT JUMP (BEAT JUMP 2)] button while pressing the [SHIFT] button while in any mode other than Beat Jump mode to switch to Beat Jump 2 mode.

2 Press a Performance Pad.

The playback point jumps by the number of beats or bars assigned to the Performance Pad.

- The number of beats or bars for Beat Jump/Loop Move is assigned to the Performance Pads as follows.

Beat Jump mode:

1/2 beat REV	1/2 beat FWD	1 beat REV	1 beat FWD
2 beats REV	2 beats FWD	4 beats REV	4 beats FWD

Beat Jump 2 mode:

8 beats REV	8 beats FWD	16 beats REV	16 beats FWD
32 beats REV	32 beats FWD	64 beats REV	64 beats FWD

- If you do this during loop playback, a loop is moved by the number of beats.

Audio output

Follow the procedures below to output and adjust sound.

- Outputting sound (page 105)
- Adjusting the sound (page 106)
- Setting the faders (page 107)

Channel section/master section

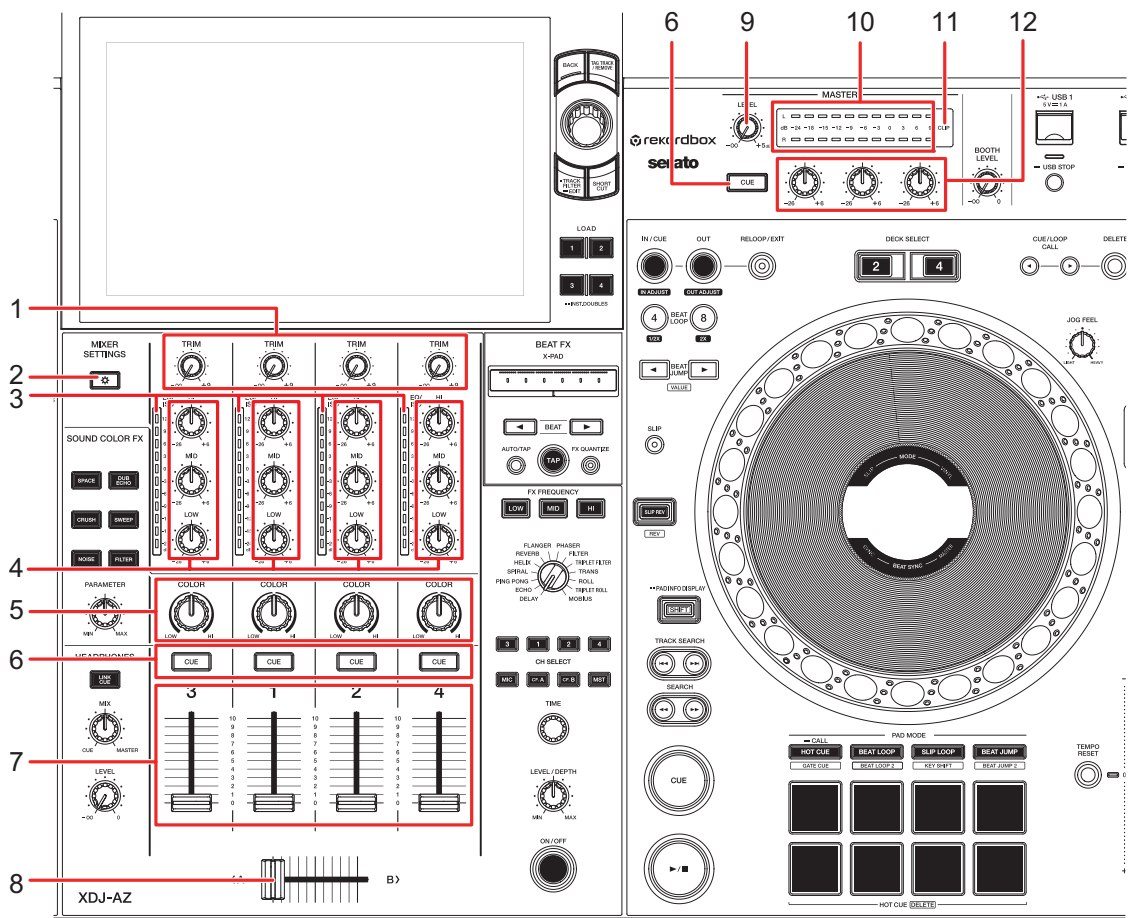

❖ Channel section

1. TRIM knob

Adjusts the volume for the channel input sound.

2. **MIXER SETTINGS** button

Displays the [**MIXER SETTINGS**] screen (page 147).

3. **Channel level indicator**

Displays the volume level before the sound passes through the channel fader.

4. **EQ/ISO (HI, MID, LOW) knobs**

Adjusts the volume of each frequency band.

Each knob adjusts in the following range.

- [**HI**]: $-\infty$ dB to +6 dB (ISO)/-26 dB to +6 dB (EQ)
- [**MID**]: $-\infty$ dB to +6 dB (ISO)/-26 dB to +6 dB (EQ)
- [**LOW**]: $-\infty$ dB to +6 dB (ISO)/-26 dB to +6 dB (EQ)

5. **COLOR knob** (page 116)

6. **CUE button** (page 109)

7. **Channel fader**

Adjusts the volume for the channel output sound according to the channel fader curve set with [**Channel Fader Curve**] in the Utility settings or on the [**MIXER SETTINGS**] screen (pages 134, 148). Moving it up increases the volume, and down decreases the volume.

8. **Crossfader**

Adjusts the volume balance between the channel output sounds specified with [**DECK1/2/3/4 Crossfader Assign**] in the Utility settings (page 135) or [**Cross Fader Assign**] on the [**MIXER SETTINGS**] screen (page 148) according to the crossfader curve specified with [**Crossfader Curve**] (pages 134, 148).

❖ **Master section**

9. **MASTER LEVEL knob**

Adjusts the volume for the master sound.

10. **Master level indicator**

Displays the volume level of the master sound output to the [**MASTER 1**] and [**MASTER 2**] terminals.

11. **CLIP indicator**

Blinks when excessive volume is output from the [**MASTER 1**] or [**MASTER 2**] terminals.

12. **Master EQ (HI, MID, LOW) knobs**

Adjusts the volume of master sound.

Outputting sound

Adjusting the channel input volume

- 1 Press the [MIXER SETTINGS] button or press and hold the [MENU] button.**

The [MIXER SETTINGS] or [UTILITY] screen appears.

- 2 Select the input source in [DECK3/4 Input Select].**

- Skip this step when outputting the sound of Deck 1 or Deck 2.

- 3 Turn the [TRIM] knob to adjust the volume for the input sound.**

The channel level indicator lights up when sound is input to the channel.

Adjusting the channel output volume

- 1 Move the channel fader to adjust the volume for the output sound.**

- 2 Press the [MIXER SETTINGS] button or press and hold the [MENU] button.**

The [MIXER SETTINGS] or [UTILITY] screen appears.

- 3 Select the output destination of the channel in [Crossfader Assign] or [DECK1/2/3/4 Crossfader Assign].**

- 4 Move the crossfader to adjust the volume balance of the two channels.**

- You don't need to adjust the crossfader when the output destination is set to [THRU].

Adjusting the master sound volume

- 1 Turn the **[MASTER LEVEL]** knob to adjust the volume for the master sound.

The master level indicator lights up when the master sound is output.

Adjusting the sound

- 1 Turn the **[EQ/ISO (HI, MID, LOW)]** knobs to adjust the volume of each band.
 - Set the function (equalizer or isolator) to adjust with the **[EQ/ISO (HI, MID, LOW)]** knobs in **[EQ / ISO]** in the Utility settings or on the **[MIXER SETTINGS]** screen (pages 134, 148).
- 2 Turn the **Master EQ [HI, MID, LOW]** knobs to adjust the volume of master sound.
 - Set the function (**[Master Out]** or **[Master and Booth Out]**) to adjust with the Master EQ **[HI, MID, LOW]** knobs in **[Master EQ]** in the Utility settings (page 135).

Setting the faders

Set the channel fader and crossfader.

Setting the channel fader

- 1 Press the **[MIXER SETTINGS]** button or press and hold the **[MENU]** button.

The **[MIXER SETTINGS]** or **[UTILITY]** screen appears.

- 2 Set the channel fader curve in **[Channel Fader Curve]**.





➤ Read more: Channel Fader Curve (pages 134, 148).

Setting the crossfader

- 1 Press the **[MIXER SETTINGS]** button or press and hold the **[MENU]** button.

The **[MIXER SETTINGS]** or **[UTILITY]** screen appears.

- 2 Select the crossfader curve in **[Crossfader Curve]**.

- : Steeply raises the volume of the sound assigned to the other side as the crossfader is moved from one side (**[A]** or **[B]**) to the other (e.g. moving the crossfader away from the **[A]** side steeply increases the volume of the **[B]** side).
- : Applies the intermediate setting between  and .
- : Gradually raises the volume of the sound assigned to the other side as the crossfader is moved from one side (**[A]** or **[B]**) to the other, and decreases the volume of the sound on the side it's moving away from (e.g. moving the crossfader away from the **[A]** side gradually increases the volume of the **[B]** side while gradually decreasing the volume of the **[A]** side).

➤ Read more: Crossfader Curve (pages 134, 148)

Monitoring sound

Headphones section

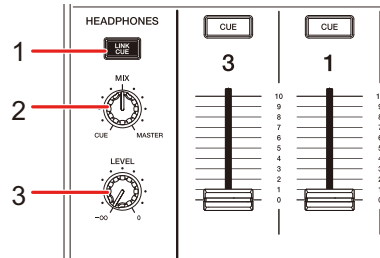

1. **LINK CUE** (page 57)

2. **MIX knob**

Adjusts the volume balance between the master sound and the sound of the channel selected with the **[CUE]** button.

- Set the knob to **[CUE]** to monitor only the sound of the selected channel, or set it to **[MASTER]** to monitor only the master sound.

3. **LEVEL knob**

Adjusts the volume for sound output from the **[PHONES]** terminals.

- You can adjust the Link Cue volume in **[LINK Preview Volume]** in the Utility settings or on the **[MIXER SETTINGS]** screen (pages 135, 148).

Monitoring with headphones

1 Connect headphones to one of the PHONES terminals.

🔗 Read more: Front panel (page 32)

2 Press the [CUE] button on a channel to monitor the channel's sound.

- You can set the sound output (Stereo or Mono Split) in [Headphones Stereo / Mono Split] in the Utility settings or on the [MIXER SETTINGS] screen (pages 135, 148).

3 Turn the [MIX] knob to adjust the volume balance between the channel sound and the master sound.

4 Turn the [LEVEL] knob to adjust the volume.

Monitoring sound with SonicLink headphones

1 Press and hold the [MENU] button.

The [UTILITY] screen appears.

2 Select [SonicLink] in the Mixer category.

The [SonicLink] screen appears.

3 Turn SonicLink on.

The SonicLink headphones indicator blinks slowly.

4 Press and hold the [PAIRING] button.

The unit enters pairing state.

- The SonicLink headphones indicator blinks fast during pairing state.

- If you use headphones that have been registered to the unit before, the unit automatically connects to them when you turn them on – there's no need to use the **[PAIRING]** button.

➡ Read more: Front panel (page 32)

5 Turn the SonicLink headphones on, then perform the pairing procedure.

- For details on the pairing procedure for the SonicLink headphones, refer to the instruction manual for the SonicLink headphones.

6 Press the [CUE] button of the channel you want to monitor.

- You can set the sound output (Stereo or Mono Split) in **[Headphones Stereo / Mono Split]** in the Utility settings or on the **[MIXER SETTINGS]** screen (pages 135, 148).

7 Turn the [MIX] knob to adjust the volume balance between the channel sound and the master sound.

8 Turn the [LEVEL] knob to adjust the volume.

Booth section

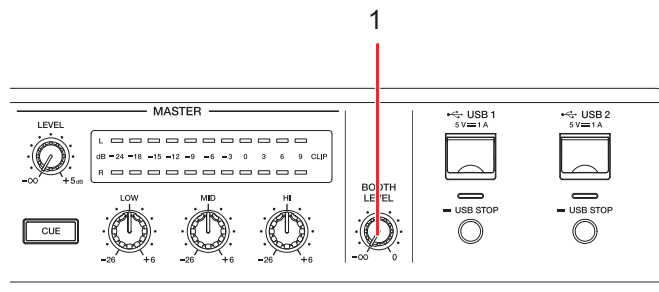

1. BOOTH LEVEL knob

Adjusts the volume for the sound output to a booth monitor.

Using a booth monitor

1 Connect a booth monitor to the [BOOTH] terminals.

➡ Read more: Rear panel (page 32)

2 Turn the [BOOTH LEVEL] knob to adjust the volume for the output sound.

Microphone

MIC section

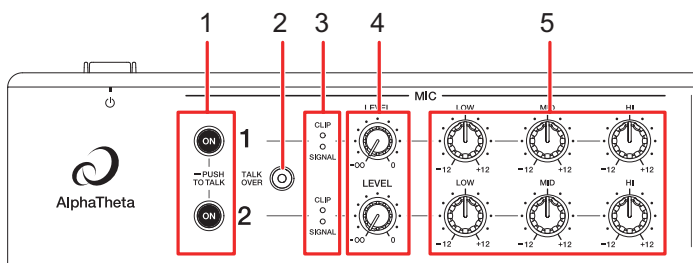

1. ON button

Sets the microphone sound output. The button lights up when the microphone is turned on.

Press and hold to turn Push To Talk on. The microphone is turned on while pressing the button.

2. TALK OVER button

Turns microphone talkover on and off. If sound is input to the microphone when it's turned on, the volume other than the microphone channel is attenuated.

- You can change the talkover mode setting and attenuation level in **[Talkover Mode]** and **[Talkover Level]** in the Utility settings (page 136).

3. CLIP/SIGNAL indicator

4. LEVEL knob

Adjusts the volume of sound input from the **[MIC 1]** or **[MIC 2]** terminal.

5. MIC EQ (HI, MID, LOW) knobs

Adjusts the volume of sound input from the **[MIC 1]** or **[MIC 2]** terminal.

Each knob adjusts in the following range.

- **[HI]**: -12 dB to +12 dB (10 kHz)
- **[MID]**: -12 dB to +12 dB (2.5 kHz)
- **[LOW]**: -12 dB to +12 dB (100 Hz)

Using a microphone

1 Connect a microphone to the [MIC 1] or [MIC 2] terminal.

➡ Read more: Rear panel (page 32)

2 Press the [ON] button to turn the microphone on.

The microphone turns on and the [ON] button lights up.

3 Turn the [LEVEL] knob to adjust the microphone volume level.

- Note that turning the knob too far clockwise outputs the sound at a high volume.

4 Turn the MIC EQ [HI, MID, LOW] knobs to adjust the volume of each band.

5 Speak into the microphone.

Reducing the “howling” noise of a microphone (Feedback Reducer)

When microphone “howling” noise occurs (feedback), the unit detects the relevant frequency and cuts only that frequency band to reduce the “howling” while minimizing the effect on sound quality.

1 Press the [MIXER SETTINGS] button or press and hold the [MENU] button.

The [MIXER SETTINGS] or [UTILITY] screen appears.

2 Select a mode in [Feedback Reducer].

- **[Heavy]**: The filter cuts a wide frequency band. Choose this setting when your priority is reducing “howling” noise, e.g. when you’re using a microphone for a speech or to introduce speakers.
- **[Light]**: The filter cuts a narrow frequency band. Choose this setting when you want to prioritize sound quality, e.g. when you’re singing or rapping.
- Select **[Off]** to turn off **[Feedback Reducer]**.

Sound Color FX

Sound Color FX section

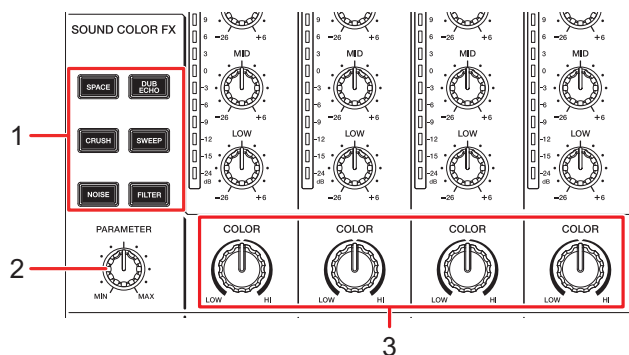

1. **SOUND COLOR FX buttons**
Select a SOUND COLOR FX.
2. **PARAMETER knob**
Adjusts a filter or an effect.
3. **COLOR knobs**
Adjusts an effect.

Using Sound Color FX

➡ Read more: Sound Color FX types and settings (page 117)

1 Press a [SOUND COLOR FX] button.

The selected button blinks.

- The effect is applied to CH 1 to CH 4.

2 Turn the [COLOR] knob to adjust the effect.

The effect on the channel you turned the knob for is adjusted.

3 Turn the [PARAMETER] knob to adjust the quantitative parameter for the effect.

- Press the button of the effect you're using again to turn the effect off.

Sound Color FX types and settings

You can adjust the following settings with the knobs.

Effect/operation	Description
SPACE	Adds reverberation to the original sound.
<ul style="list-style-type: none"> • COLOR: 	<p>Turn counterclockwise to add reverberation to the middle frequency range and low frequency range.</p> <p>Turn clockwise to add reverberation to the middle frequency range and high frequency range.</p>
<ul style="list-style-type: none"> • PARAMETER: 	Feedback
DUB ECHO	Adds reverberating echo by outputting the sounds slightly delayed from the original sound several times and attenuating them.
<ul style="list-style-type: none"> • COLOR: 	<p>Turn counterclockwise to add reverberating echo to the middle frequency range.</p> <p>Turn clockwise to add reverberating echo to the high frequency range.</p>
<ul style="list-style-type: none"> • PARAMETER: 	Feedback
SWEEP	Adds a notch filter effect or a bandpass filter effect.
<ul style="list-style-type: none"> • COLOR: 	<p>Turn counterclockwise to gradually increase the bandwidth of the notch filter.</p> <p>Turn clockwise to gradually narrow the bandwidth of the bandpass filter.</p>
<ul style="list-style-type: none"> • PARAMETER: 	Center frequency of the filter

Effect/operation	Description
NOISE	Outputs filtered white noise mixed with the sound of the channel.
<ul style="list-style-type: none"> • COLOR: 	<p>Turn counterclockwise to lower the cut-off frequency for the filter which passes white noise through.</p> <p>Turn clockwise to raise the cut-off frequency for the filter which passes white noise through.</p>
<ul style="list-style-type: none"> • PARAMETER: 	Volume of the noise
<ul style="list-style-type: none"> • EQ/ISO (HI, MID, LOW): 	Noise quality
CRUSH	Outputs a 'crushed' version of the original sound.
<ul style="list-style-type: none"> • COLOR: 	<p>Turn counterclockwise to increase sound distortion.</p> <p>Turn clockwise to pass the crush sound through the high-pass filter.</p>
<ul style="list-style-type: none"> • PARAMETER: 	Crush effect
FILTER	Outputs filtered sound.
<ul style="list-style-type: none"> • COLOR: 	<p>Turn counterclockwise to lower the cut-off frequency of the low-pass filter.</p> <p>Turn clockwise to raise the cut-off frequency of the high-pass filter.</p>
<ul style="list-style-type: none"> • PARAMETER: 	Resonance

Beat FX

Beat FX section

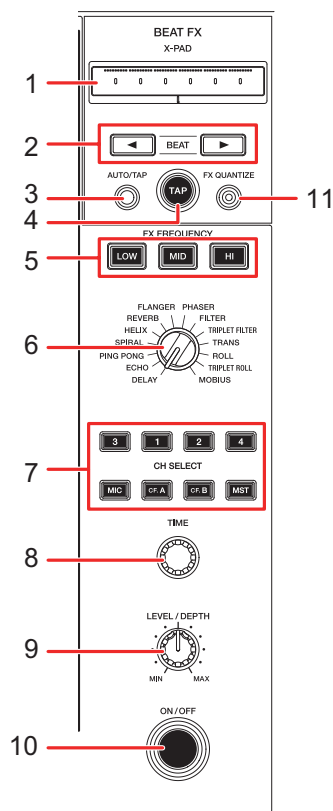

1. X-PAD

Touch to turn an effect on and off. You can adjust the time and quantitative parameters when you touch or slide your finger on X-PAD.

2. BEAT ◀, ▶ buttons

Sets the number of beats for Beat FX.

3. AUTO/TAP button

Sets BPM measuring method (AUTO/TAP).

- [AUTO]: Automatically measures BPM of the input sound. It's automatically set to AUTO mode when the unit is turned on.
- [TAP]: Manually sets a BPM by tapping the [TAP] button.

4. **TAP button**

Manually sets a BPM by tapping the **[TAP]** button when BPM measuring mode is set to **[TAP]**.

5. **FX FREQUENCY (LOW, MID, HI) buttons**

Selects the range (LOW/MID/HI) to apply Beat FX to. The selected button lights up.

6. **BEAT FX selector switch**

Selects a Beat FX.

7. **CH SELECT button**

Selects a channel to apply a Beat FX to.

8. **TIME knob**

Adjusts the time parameter for Beat FX.

9. **LEVEL/DEPTH knob**

- Turn the knob all the way counterclockwise to output the original sound.

10. **ON/OFF button**

Turns Beat FX on and off. The button blinks when the effect is turned on.

11. **FX QUANTIZE button**

Turns on and off Quantize for Beat FX. If you use Quantize, the unit adds an effect by automatically synchronizing it with the beat according to the track's grid information analyzed by rekordbox or this unit.

Using Beat FX

➤ Read more: Beat FX types and settings (page 123)

- 1 Turn the BEAT FX selector switch to select a Beat FX.**
- 2 Press a [CH SELECT] button to apply Beat FX to.**
 - To apply Beat FX to the microphone sound, you can select a microphone to apply Beat FX to in **[BEAT FX MIC]** in the Utility settings or on the **[MIXER SETTINGS]** screen (pages 136, 148).
 - **[MIC1]**: Applies Beat FX to MIC 1.
 - **[MIC2]**: Applies Beat FX to MIC 2.
 - **[MIC1+MIC2]**: Applies Beat FX to MIC 1 and MIC 2.
- 3 Press the [BEAT ◀] or [BEAT ▶] button to set a beat fraction to synchronize the effect with.**
- 4 Press the [FX FREQUENCY (LOW, MID, HI)] button to select the range to apply Beat FX to.**
- 5 Turn the [TIME] knob and [LEVEL/DEPTH] knob to adjust the effect.**
- 6 Press the [ON/OFF] button or touch X-PAD to turn the Beat FX on.**

The Beat FX is applied to the selected channel.

- Press the **[ON/OFF]** button again or release X-PAD to turn the Beat FX off.
- If you use Quantize for Beat FX, the unit adds an effect by automatically synchronizing it with the beat according to the track's grid information analyzed by rekordbox or this unit.

Setting BPM manually (Tap mode)

1 Tap the [TAP] button more than twice in time with the beat of the track.

BPM is set according to the average time between taps.

- The beat fraction is set to 1/1 when you set BPM with the [TAP] button, and the length of one beat is set as the effect time.
- Turn the [TIME] knob while pressing the [TAP] button to adjust BPM in increments of 1.
- Press the [BEAT ◀] or [BEAT ▶] button while pressing the [TAP] button to adjust BPM in increments of 0.1.

Beat FX types and settings

You can adjust the following settings with the buttons and knobs.

Beat FX/operation	Description
DELAY ¹ ²	Outputs a delay sound once according to the beat.
<ul style="list-style-type: none"> • BEAT ◀, ▶: • TIME: • LEVEL/DEPTH: • X-PAD: 	<p>Delay time with respect to 1 beat of the BPM (beat fraction): 1/16 to 16 beats</p> <p>Delay time: 1 to 4 000 (ms)</p> <p>Balance between the original sound and the effected sound</p> <p>Delay time</p>
ECHO ¹ ²	Outputs a delay sound several times while attenuating it according to the beat.
<ul style="list-style-type: none"> • BEAT ◀, ▶: • TIME: • LEVEL/DEPTH: • X-PAD: 	<p>Delay time with respect to 1 beat of the BPM (beat fraction): 1/16 to 16 beats</p> <p>Delay time: 1 to 4 000 (ms)</p> <p>Balance between the original sound and the effected sound</p> <p>Delay time</p>
PING PONG ¹ ²	Outputs a delay sound with different delay times for the left and right several times while attenuating it according to the beat, producing a stereo-like effect.
<ul style="list-style-type: none"> • BEAT ◀, ▶: • TIME: • LEVEL/DEPTH: • X-PAD: 	<p>Delay time with respect to 1 beat of the BPM (beat fraction): 1/16 to 16 beats</p> <p>Delay time: 10 to 4 000 (ms)</p> <p>Balance between the original sound and the effected sound</p> <p>Delay time</p>

Beat FX/operation	Description
SPIRAL 1 2	Adds reverberation to the input sound.
• BEAT ◀, ▶:	Delay time with respect to 1 beat of the BPM (beat fraction): 1/16 to 16 beats
• TIME:	Delay time: 10 to 4 000 (ms)
• LEVEL/DEPTH:	Balance between the original sound and the effected sound, and feedback
• X-PAD:	Delay time
HELIX	Records the input sound and outputs the recorded sound repeatedly according to the specified time parameter.
• BEAT ◀, ▶:	Effect time with respect to 1 beat of the BPM (beat fraction): 1/16 to 16 beats
• TIME:	Effect time: 10 to 4 000 (ms)
• LEVEL/DEPTH:	Ratio of sound overlay <ul style="list-style-type: none"> You can change the attenuation rate by turning the [LEVEL/DEPTH] knob all the way counterclockwise and then clockwise. Turn the knob all the way clockwise to fix the output sound.
• X-PAD:	Effect time
REVERB 1 2	Adds reverberation to the input sound.
• BEAT ◀, ▶:	Reverberation level: 1 to 100%
• TIME:	Reverberation level: 1 to 100%
• LEVEL/DEPTH:	Balance between the original sound and the effected sound
• X-PAD:	Cut-off frequency for filter

Beat FX/operation	Description
FLANGER	Adds a cyclic flanger effect according to the beat.
• BEAT ◀, ▶:	Moving cycle of the effect with respect to 1 beat of the BPM (beat fraction): 1/16 to 64 beats
• TIME:	Moving cycle of the effect: 10 to 32 000 (ms)
• LEVEL/DEPTH:	Effect level
• X-PAD:	Moving cycle of the effect
PHASER	Adds a cyclic phaser effect according to the beat.
• BEAT ◀, ▶:	Moving cycle of the effect with respect to 1 beat of the BPM (beat fraction): 1/16 to 64 beats
• TIME:	Moving cycle of the effect: 10 to 32 000 (ms)
• LEVEL/DEPTH:	Effect level
• X-PAD:	Moving cycle of the effect
FILTER	Cyclically changes the cut-off frequency according to the beat.
• BEAT ◀, ▶:	Moving cycle of the effect with respect to 1 beat of the BPM (beat fraction): 1/16 to 64 beats
• TIME:	Moving cycle of the effect: 10 to 32 000 (ms)
• LEVEL/DEPTH:	Effect level
• X-PAD:	Moving cycle of the effect

Beat FX/operation	Description
TRIPLET FILTER	Cyclically changes the cut-off frequency, based on 3 beats, according to the beat.
<ul style="list-style-type: none"> • BEAT ◀, ▶: Moving cycle of the effect with respect to 1 beat of the BPM (beat fraction): 1/12 to 12/3 beats • TIME: Moving cycle of the effect: 10 to 32 000 (ms) • LEVEL/DEPTH: Effect level • X-PAD: Moving cycle of the effect 	
TRANS	Cyclically cuts the sound according to the beat.
<ul style="list-style-type: none"> • BEAT ◀, ▶: Cycle of the cut with respect to 1 beat of the BPM (beat fraction): 1/16 to 16 beats • TIME: Effect time: 10 to 16 000 (ms) • LEVEL/DEPTH: Balance between the original sound and the effected sound, and duty • X-PAD: Cycle of the cut 	
ROLL	Records the input sound when the effect is turned on, and outputs the recorded sound repeatedly according to the specified beat fraction.
<ul style="list-style-type: none"> • BEAT ◀, ▶: Effect time with respect to 1 beat of the BPM (beat fraction): 1/16 to 16 beats • TIME: Effect time: 10 to 4 000 (ms) • LEVEL/DEPTH: Balance between the original sound and the effected sound • X-PAD: Effect time 	

Beat FX/operation	Description
TRIPLET ROLL	Records the input sound when the effect is turned on, and outputs the recorded sound repeatedly, based on 3 beats, according to the specified beat fraction.
<ul style="list-style-type: none"> • BEAT ◀, ▶: • TIME: • LEVEL/DEPTH: • X-PAD: 	<p>Effect time with respect to 1 beat of the BPM (beat fraction): 1/12 to 12/3 beats</p> <p>Effect time: 10 to 4 000 (ms)</p> <p>Balance between the original sound and the effected sound</p> <p>Effect time</p>
MOBIUS	Changes the frequency of the sounding oscillator to keep rising or falling in time with the beat.
<ul style="list-style-type: none"> • BEAT ◀, ▶: • TIME: • LEVEL/DEPTH: • X-PAD: 	<p>Moving cycle of the effect with respect to 1 beat of the BPM (beat fraction): 1/16 to 64 beats/-64 to -1/16 beats</p> <p>Moving cycle of the effect: 10 to 32 000/-32 000 to -10 (ms)</p> <p>Volume of the oscillator</p> <p>Waveform of the oscillator</p>

- ¹ When the Beat FX channel selector is set to a channel from CH 1 to CH 4, you can't monitor the effected sound even if you press the [CUE] button for the relevant channel.
- ² Only the effect sound remains if you set the channel fader to the [0] position to cut the input sound (the effect sound remains even after the effect is turned off).

Using DJ software

If you connect a PC/Mac with MIDI software installed, to the unit via a USB cable, you can control the DJ software via the unit.

- To play tracks stored on a PC with the unit, install the dedicated audio driver software (page 16). If you use a Mac, you don't have to install the dedicated audio driver software.
- For details on the unit's MIDI messages, visit the URL below.

alphatheta.com/support/

- Install DJ software and configure the audio and MIDI settings on a PC/Mac beforehand.
- You don't need to make MIDI settings when you use rekordbox or Serato DJ Pro with the unit.
- It's recommended to connect this unit and a PC/Mac directly with a USB cable. When using a USB hub, use a product recommended by the manufacturer of your PC/Mac. We don't guarantee the operation of all USB hubs.

Controlling DJ software

1 Connect a PC/Mac to the unit.

➡ Read more: Rear panel (page 32)

2 Press the [SOURCE] button.

The [SOURCE] screen appears.

3 Select [SOFTWARE CONTROL].

The [SOFTWARE CONTROL] screen appears.

4 Press the [LOAD 1/2/3/4] button.

The deck on which you press the button switches to control mode.

5 Launch the DJ software.

The unit starts communication with the DJ software.

Using DJ software

- Some buttons on the unit can't be used for controlling a DJ application.
- Control mode turns off when a track is loaded to the unit from a device other than the currently communicating device that's running the DJ software.

Settings

You can change the settings of the unit from the Utility menu, on the **[SHORTCUT]** screen or **[MIXER SETTINGS]** screen.

If you save My Settings (function settings of the unit) to a storage device, you can load them to the unit immediately when you arrive in the booth or take over from another DJ, etc.

Changing the settings

1 Press and hold the **[MENU]** button.

The **[UTILITY]** screen appears.

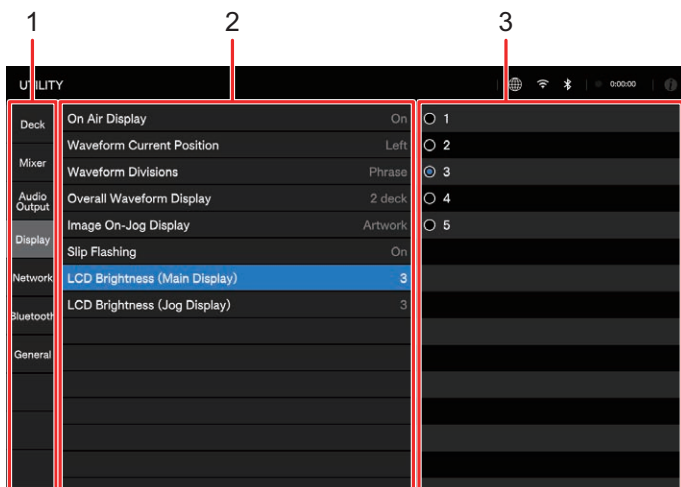

1. **Category**
2. **Setting items and current setting values**
3. **Setting values**

2 Select a category.

3 Select a setting item.

➤ Read more: Utility settings (page 131)

4 Select a setting value.

- Press the **[MENU]** button to close the **[UTILITY]** screen.

Utility settings

❖ Deck category

*: Factory setting

Setting item	Description
Eject/Load Lock	<p>Eject Lock: Determines whether or not you can unload a loaded track during playback.</p> <p>Load Lock: Determines whether or not you can load another track during playback.</p> <ul style="list-style-type: none"> Setting values: Unlock*, Lock [Eject Lock]: <ul style="list-style-type: none"> [Unlock]: You can unload a loaded track during playback. [Lock]: You can't unload a loaded track during playback. [Load Lock]: <ul style="list-style-type: none"> [Unlock]: You can load another track during playback. [Lock]: You can't load another track during playback.
Quantize Beat Value (Deck)	<p>Sets the number of beats for Quantize.</p> <ul style="list-style-type: none"> Setting values: 1/8 Beat, 1/4 Beat, 1/2 Beat, 1 Beat*
Hot Cue Auto Load	<p>Determines whether or not Hot Cues/Loops are automatically called up when you load a track (page 97).</p> <ul style="list-style-type: none"> Setting values: Off, On*
Hot Cue Color	<p>Turns on and off the lighting color setting for the [HOT CUE] (A to H) buttons (page 94).</p> <ul style="list-style-type: none"> Setting values: Off*, On
Overwrite Current Cue with Hot Cue (Smart Cue)	<p>Determines whether or not a cue point is automatically set when a Hot Cue/Loop is set or playback starts from a Hot Cue/Loop (pages 76, 94, 95).</p> <ul style="list-style-type: none"> Setting values: Off*, On







Setting item	Description
Auto Cue Level	<p>Sets the sound pressure level that Auto Cue recognizes as silence.</p> <ul style="list-style-type: none"> Setting values: Memory Cue*, Hot Cue, -78dB, -72dB, -66dB, -60dB, -54dB, -48dB, -42dB, -36dB [Memory Cue]: Sets the saved cue/loop point closest to the beginning of a track to an Auto Cue point. [Hot Cue]: Sets the saved Hot Cue/Loop point closest to the beginning of a track to an Auto Cue point.
Vinyl Speed Adjust	<p>Sets the adjustment method for the playback starting and stopping speeds in Vinyl mode (page 75).</p> <ul style="list-style-type: none"> Setting values: Touch&Release, Touch*, Release
Vinyl Speed Adjust Time	<p>Sets the Vinyl Speed Adjust speed (page 75).</p> <ul style="list-style-type: none"> Setting values: 1, 2, 3*, 4, 5
Play Mode	<p>Sets playback mode.</p> <ul style="list-style-type: none"> Setting values: Continue, Single* [Continue]: Automatically loads the next track when playback reaches the end of a track. [Single]: Stops playback when playback reaches the end of a track. The next track isn't automatically loaded.
Jog Ring Brightness	<p>Sets the brightness of the jog ring illumination.</p> <ul style="list-style-type: none"> Setting values: Off, 1, 2*
Jog Ring Indicator	<p>Determines whether or not to blink the jog ring illumination when playback reaches the end of a track.</p> <ul style="list-style-type: none"> Setting values: Off, On*

Setting item	Description
PRO DJ LINK Mode	<p>Sets whether or not to connect the unit with a PRO DJ LINK compatible player.</p> <ul style="list-style-type: none"> Setting values: Off*, On When set to [On], you can't use Deck 3 and Deck 4 on the unit. You can't connect the unit with a PRO DJ LINK compatible player while the internal wireless connection (Wi-Fi) on the unit is being used.

❖ Mixer category

*: Factory setting

Setting item	Description
Channel Input Select Memory	<p>Determines whether or not to save the [DECK3 Input Select] and [DECK4 Input Select] settings.</p> <ul style="list-style-type: none"> Setting values: Off*, On The setting isn't saved when [Bluetooth] is selected. Instead, [DECK/] is selected when the unit is turned on. If the setting is saved when [PHONO] is selected, sound may be output at a high volume depending on the signal input to the unit when it's turned on. Make sure the input signal is appropriate for the settings to avoid this.
DECK3 Input Select	<p>Sets the input source for Deck 3 from devices connected to the unit.</p> <ul style="list-style-type: none"> Setting values: DECK/], LINE, PHONO, Bluetooth [DECK/]: Selects the deck of the unit or a PC/Mac connected to the USB port of the unit. [LINE]: Selects a multi player, etc., connected to the [LINE/PHONO] terminals on the unit. [PHONO]: Selects a turntable, etc., connected to the [LINE/PHONO] terminals on the unit. [Bluetooth]: Selects a PC/Mac or mobile device connected to the unit via Bluetooth.

Setting item	Description
DECK4 Input Select	<p>Sets the input source for Deck 4 from devices connected to the unit.</p> <ul style="list-style-type: none"> Setting values: DECK/☐ , LINE, PHONO, Bluetooth [DECK/☐]: Selects the deck of the unit or a PC/Mac connected to the USB port of the unit. [LINE]: Selects a multi player, etc., connected to the [LINE/PHONO] terminals on the unit. [PHONO]: Selects a turntable, etc., connected to the [LINE/PHONO] terminals on the unit. [Bluetooth]: Selects a PC/Mac or mobile device connected to the unit via Bluetooth.
CH3 Control Tone	<p>Sets the time code signal to send to CH 3 from devices connected to the [PHONO] or [LINE] input terminals.</p> <ul style="list-style-type: none"> Setting values: LINE*, PHONO
CH4 Control Tone	<p>Sets the time code signal to send to CH 4 from devices connected to the [PHONO] or [LINE] terminals.</p> <ul style="list-style-type: none"> Setting values: LINE*, PHONO
EQ / ISO	<p>Sets the function (equalizer or isolator) to adjust with the [EQ/ISO (HI, MID, LOW)] knobs.</p> <ul style="list-style-type: none"> Setting values: EQ*, ISO
Channel Fader Curve	<p>Sets the channel fader curve (page 107).</p> <ul style="list-style-type: none"> Setting values:  Curve1,  Curve2*,  Curve3
Crossfader Curve	<p>Sets the crossfader curve (page 107).</p> <ul style="list-style-type: none"> Setting values:  Curve1*,  Curve2,  Curve3

Setting item	Description
Master EQ	<p>Sets the function ([Master Out] or [Master and Booth Out]) to adjust with the Master EQ [HI, MID, LOW] knobs (page 106).</p> <ul style="list-style-type: none"> Setting values: Master Out*, Master and Booth Out [Master Out]: Applies Master EQ only to the master sound. [Master and Booth Out]: Applies Master EQ to the master sound and booth monitor sound.
DECK1 Crossfader Assign	Assigns the channel output sound to the crossfader.
DECK2 Crossfader Assign	<ul style="list-style-type: none"> Setting values: A, THRU*, B
DECK3 Crossfader Assign	<ul style="list-style-type: none"> [A]: Assigns to the [A] (left) side. [THRU]: Bypasses the crossfader.
DECK4 Crossfader Assign	<ul style="list-style-type: none"> [B]: Assigns to the [B] (right) side.
SonicLink	<p>Turns SonicLink on and off.</p> <ul style="list-style-type: none"> Setting values: Off, On*
Headphones Stereo / Mono Split	<p>Sets the output method ([Stereo] or [Mono Split]) for the headphones monitor sound.</p> <ul style="list-style-type: none"> Setting values: Stereo*, Mono Split
LINK Preview Volume	<p>Sets the attenuation level of the Link Cue sound.</p> <ul style="list-style-type: none"> Setting values: -9dB, -6dB, -3dB, 0dB*
USB Output Level	<p>Sets the attenuation level of the sound output from the USB port (Type-C).</p> <ul style="list-style-type: none"> Setting values: -19dB*, -15dB, -10dB, -5dB
Mic Output to Booth	<p>Determines whether or not to output the microphone sound to the [BOOTH] terminals.</p> <ul style="list-style-type: none"> Setting values: Off, On*

Setting item	Description
Mic Output to Master REC	<p>Determines whether or not to output the microphone sound to Master Rec (recording sound).</p> <ul style="list-style-type: none"> Setting values: Off, On*
Mic Output to USB	<p>Determines whether or not to output the microphone sound to the USB port (Type-C).</p> <ul style="list-style-type: none"> Setting values: Off, On*
BEAT FX MIC	<p>Sets the microphone to apply Beat FX to (page 121).</p> <ul style="list-style-type: none"> Setting values: MIC1, MIC2, MIC1+2*
Feedback Reducer	<p>Sets Feedback Reducer that cuts only that frequency band to reduce the “howling” while minimizing the effect on sound quality when microphone “howling” noise occurs (feedback) (page 114).</p> <ul style="list-style-type: none"> Setting values: Off, Light, Heavy*
Talkover Mode	<p>Sets Talkover mode.</p> <ul style="list-style-type: none"> Setting values: Advanced*, Normal [Advanced]: Outputs sound by attenuating only the mid-frequency range of the sound from channels other than the Mic channels according to the setting of the [LEVEL] knob. [Normal]: Outputs sound by attenuating the sound from channels other than the Mic channels according to the [LEVEL] knob setting.
Talkover Level	<p>Sets the sound attenuation level for Talkover.</p> <ul style="list-style-type: none"> Setting values: -24dB, -18dB*, -12dB, -6dB

❖ Audio Output category

*: Factory setting

Setting item	Description
Master Attenuator	<p>Sets the attenuation level of the sound output from the [MASTER 1] and [MASTER 2] terminals.</p> <ul style="list-style-type: none"> Setting values: -12dB, -6dB, 0dB*
Master Peak Limiter	<p>Sets whether or not to reduce sudden and unpleasant digital clips that occur on the master output.</p> <ul style="list-style-type: none"> Setting values: Off, On*
Master Mono / Stereo	<p>Sets the output method (monaural or stereo) for the master sound.</p> <ul style="list-style-type: none"> Setting values: Mono, Stereo*
Booth Monitor Attenuator	<p>Sets the attenuation level of the sound output from the [BOOTH] terminals.</p> <ul style="list-style-type: none"> Setting values: -12dB, -6dB, 0dB*
Booth Monitor Mono / Stereo	<p>Sets the output method (monaural or stereo) for the sound output from the [BOOTH] terminals.</p> <ul style="list-style-type: none"> Setting values: Mono, Stereo*

❖ Display category

*: Factory setting

Setting item	Description
On Air Display	<p>Determines whether or not to display On Air Display.</p> <ul style="list-style-type: none"> Setting values: Off, On*
Waveform Current Position	<p>Sets where to display the current playback point (center or left) on the waveform.</p> <ul style="list-style-type: none"> Setting values: Left*, Center

Setting item	Description
Waveform Divisions	<p>Selects time scale or phrase data to display under the playing address on the overall waveform.</p> <ul style="list-style-type: none"> Setting values: Time Scale, Phrase* <ul style="list-style-type: none"> [Time Scale]: Displays scale marks at 30-second intervals. [Phrase]: Displays the phrase data analyzed by rekordbox. If phrase data isn't saved, time scale is displayed.
Overall Waveform Display	<p>Selects 2-deck display or 4-deck display for the time display and waveform display.</p> <ul style="list-style-type: none"> Setting values: 2deck*, 4deck
Image On-Jog Display	<p>Sets an image to display on the artwork display on the jog wheel.</p> <ul style="list-style-type: none"> Setting values: Artwork*, Custom Image <ul style="list-style-type: none"> [Artwork]: Displays the artwork of the loaded track. [Custom Image]: Displays a JPEG saved in the root directory of the storage device that the loaded track is saved on. Images larger than 800 x 800 pixels can't be displayed on this unit.
Slip Flashing	<p>Determines whether or not the indicators blink for buttons that can be used for Slip when you press the [SLIP] button.</p> <ul style="list-style-type: none"> Setting values: On*, Off
LCD Brightness (Main Display)	<p>Sets the brightness of the main display.</p> <ul style="list-style-type: none"> Setting values: 1, 2, 3*, 4, 5
LCD Brightness (Jog Display)	<p>Sets the brightness of the jog display.</p> <ul style="list-style-type: none"> Setting values: 1, 2, 3*, 4, 5

❖ Network category

Setting items	Description
Wi-Fi Setting	Sets up the connection via a wireless router (access point) (page 141).
Wi-Fi Frequency	Sets the Wi-Fi frequency band. • Setting values: 5GHz (Recommended)* , 2.4GHz/5GHz
Wi-Fi Address	Displays IP address and MAC address for the wireless LAN (Wi-Fi) connection.
Ethernet Info	Displays IP address and MAC address for the wired LAN connection.

❖ Bluetooth category

Setting items	Description
Bluetooth Setting	Sets up the connection via Bluetooth (page 143).

❖ General category

*: Factory setting

Setting item	Description
Language	Sets the display language.
Screen Saver	Sets the screen saver. • Setting values: Off , On* • When set to [On], the screen saver starts if: <ul style="list-style-type: none"> – You don't use the unit for more than 5 minutes when a track isn't loaded. – You don't use the unit for more than 100 minutes during pause, during cue standby, or after playback reaches the end of a track. • Use the unit to cancel the screen saver.
Power Management	Sets the Power Management function (page 140). • Setting values: Never , 20min*

Setting item	Description
Restore Defaults	Restores the settings to the factory settings. <ul style="list-style-type: none"> Setting values: Cancel*, Ok
Serial No.	Displays the serial number.
License	Displays the license information of the unit.
Version No.	Displays the version of the software on the unit.

Power Management

When **[Power Management]** is set to **[20min]**, the unit automatically enters Off mode after 20 minutes without being used in the following ways.

- No audio signal is input to the unit.
- The unit isn't connected in the PRO DJ LINK network.
- No storage device is connected to the unit.
- No PC/Mac is connected to the unit via the USB port on the rear of the unit.

Press the **[QUANTIZE]** button to exit Off mode.

- The factory setting is **[20min]**.
- Set **[Power Management]** to **[Never]** if you don't need to use the Power Management function.
- Power consumption will increase if **[Power Management]** is set to **[Never]**,

Wireless LAN (Wi-Fi®) connection

Connecting the unit to a wireless network

1 Press and hold the [MENU] button.

The [UTILITY] screen appears.

2 Select [Wi-Fi Setting] in the Network category.

The [Wi-Fi Setting] screen appears.

3 Touch [Wi-Fi] to turn it on.

The unit searches the network and available SSID are listed.

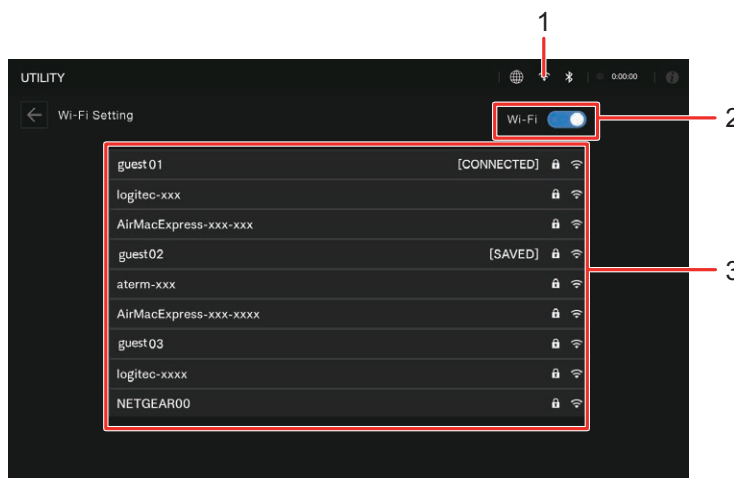

1.  (Wi-Fi connection icon)
2. Wi-Fi On/Off
3. SSID list

4 Touch the network (SSID) you want to use.

The password input screen appears.

5 Enter a password and touch [CONNECT].

If the connection succeeds, [**CONNECTED**] is displayed in the network name (SSID) field and it's displayed at the top of the list.

- You don't need to do this if you're using an access point that's connected with the unit previously.
- Touch the network (SSID) you're using to view its information on the network information screen. If you turn on [**AUTO-CONNECT**] on the network information screen, the unit automatically connects to the access point the next time you use it.
- To delete the networks (SSID) saved to the unit, touch [**SAVED NETWORKS**] at the bottom of the list. Select the networks (SSID) to delete in the list and touch [**FORGET THIS NETWORK**] on the network information screen.

Bluetooth[®]/MD connection

You can input the sound of your PC/Mac or mobile device to the unit via Bluetooth.

Pairing with a Bluetooth device

1 Press and hold the [MENU] button.



The [UTILITY] screen appears.

2 Select [Bluetooth Setting] in the Bluetooth category.

The [Bluetooth Setting] screen appears.

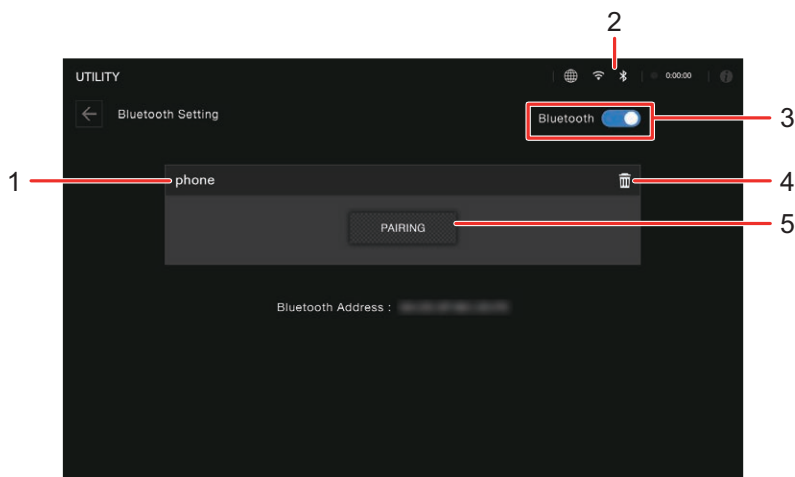
3 Touch [Bluetooth] to turn it on.



1. Name of the connected device
2.  (Bluetooth connection icon)
3. Bluetooth On/Off
4.  (Remove device)
5. PAIRING

4 Touch [PAIRING].

The unit enters pairing state.

- The Bluetooth indicator blinks while the unit is in pairing state (for approximately 2 minutes).

5 Perform the pairing procedure on a Bluetooth device.

6 Allow the connection on the unit.

The Bluetooth indicator on the unit stops blinking and lights up when the connection is established.

- Perform the pairing procedure on a Bluetooth device while the unit is in pairing state. If the unit can't pair with a Bluetooth device within 2 minutes, the Bluetooth indicator turns gray.
- For details on the pairing procedure for the Bluetooth device, refer to the device's instruction manual.
- If you use a Bluetooth device registered to the unit, the unit automatically connect the device when Bluetooth is turned on.
- You can only connect the unit to one Bluetooth device at a time. If the unit pairs with a second device, the registration of the first device will be lost. To register the first device again, perform pairing with the device.
- Touch  to connect with other Bluetooth device than the registered one.

Changing the settings on the Shortcut screen

1 Press the [SHORTCUT] button.

The [SHORTCUT] screen appears.

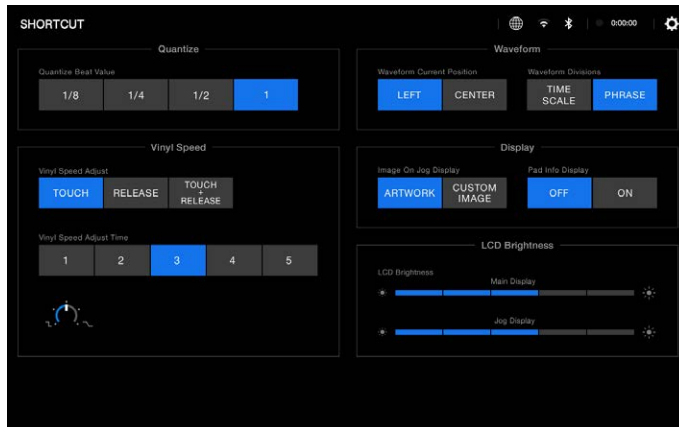

2 Select a setting value.

📖 Read more: Setting items on the Shortcut screen (page 146)

- Press the [SHORTCUT] button again to close the [SHORTCUT] screen.

Setting items on the Shortcut screen

Setting item	Description
Quantize	
Quantize Beat Value	Same as the Utility settings (page 131)
Vinyl Speed	
Vinyl Speed Adjust	Same as the Utility settings (page 131)
Vinyl SpeedAdjust Time	
Waveform	
Waveform Current Position	Same as the Utility settings (page 131)
Waveform Divisions	
Display	
Image On-Jog Display	Same as the Utility settings (page 131)
Pad Info Display	Determines whether or not to display the pad information on the jog wheel display.
LCD Brightness	
Main Display	Same as the Utility settings (page 131)
JOG Display	

Changing the settings on the Mixer Settings screen

1 Press the [MIXER SETTINGS] button.

The [MIXER SETTINGS] screen appears.

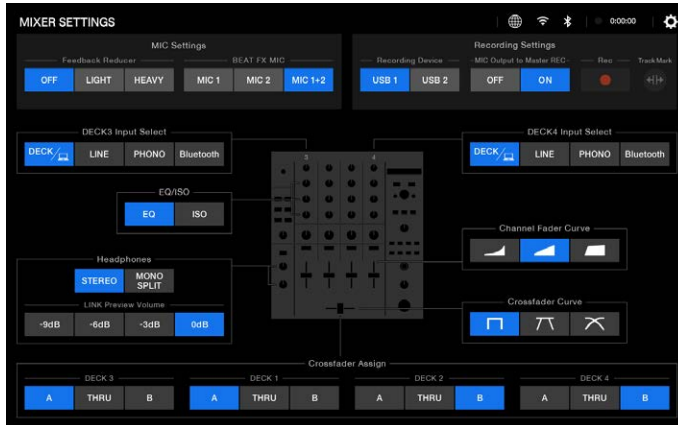

2 Select a setting value.

👉 Read more: Setting items on the Mixer Settings screen (page 148)

- Press the [MIXER SETTINGS] button again to close the [MIXER SETTINGS] screen.

Setting items on the Mixer Settings screen

Setting item	Description
Mic Settings	
Feedback Reducer	Same as the Utility settings (page 131)
BEAT FX MIC	
Recording Settings	
Recording Device	Sets a recording device (page 72).
MIC Output to Master REC	Same as the Utility settings (page 131)
Rec	Starts recording (page 72).
Track Mark	Split a track while recording (page 72).
DECK3 Input Select	
DECK4 Input Select	
EQ / ISO	
Headphones Stereo / Mono Split	Same as the Utility settings (page 131)
Channel Fader Curve	
Crossfader Curve	
LINK Preview Volume	
Cross Fader Assign	

Calling up My Settings saved on a USB device

You can call up My Settings from a USB device.

- You can call up My Settings from a storage device (connected to a player), rekordbox, or CloudDirectPlay connected in the Pro DJ Link network.

1 Connect a USB device to the unit.

➔ Read more: Connecting storage devices (page 49)

2 Press the [SOURCE] button.

The [SOURCE] screen appears.

3 Select a device.

4 Touch .

The Device Settings screen appears.

5 Touch [LOAD] in [MY SETTINGS].

My Settings are called up.

- You can't call up My Settings when a track is playing. Pause the playback before calling up the settings.
- Touch  again to close the Device Settings screen.

Specifications

General

Power requirements.....	AC 110 V – 240 V, 50 Hz/60 Hz
Power consumption	60 W
Power consumption (off)	0.3 W
Main unit weight.....	13.5 kg/29.8 lbs.
Max. external dimensions	(W × D × H) 895 × 504.1 × 133.4 mm/35.24" × 19.85" × 5.25"
Tolerable operating temperature	+5 °C – +35 °C (+41 °F – +95 °F)
Tolerable operating humidity	5 % – 85 % (no condensation)

Audio Section

Sampling rate.....	44.1 kHz
MASTER D/A converter	32bit
Other A/D and D/A converters.....	24bit

Frequency characteristic

USB, LINE, AUX (LINE/PORTABLE), MIC 1, MIC 2	20 Hz – 20 kHz
--	----------------

S / N ratio (rated output, A-WEIGHTED)

USB.....	115 dB
LINE	96 dB
PHONO	85 dB
MIC.....	79 dB

Total harmonic distortion (20 Hz – 20 kHz BW)

USB.....	0.0018 %
LINE	0.005 %

Standard input level/Input impedance

LINE	-12 dBu/47 kΩ
PHONO	-52 dBu/47 kΩ
MIC.....	-57 dBu/3 kΩ

Standard output level/Load impedance/Output impedance

MASTER 1	+6 dBu/10 kΩ/360 Ω or less
MASTER 2	+2 dBu/10 kΩ/700 Ω or less
BOOTH	+6 dBu/10 kΩ/700 Ω or less
PHONES.....	+8 dBu/32 Ω/1 Ω or less

Rated output level / Load impedance

MASTER 1	+25 dBu/10 kΩ
MASTER 2	+21 dBu/10 kΩ

Crosstalk

LINE 84 dB

Channel equalizer characteristic/Master equalizer characteristic

HI.....-26 dB – +6 dB (10 kHz)

MID.....-26 dB – +6 dB (1 kHz)

LOW.....-26 dB – +6 dB (20 Hz)

Microphone equalizer characteristic

HI.....-12 dB – +12 dB (10 kHz)

MID.....-12 dB – +12 dB (2.5 kHz)

LOW.....-12 dB – +12 dB (100 Hz)

Input/Output terminals

LINE/PHONO input terminals

RCA pin jacks 2 sets

MIC input terminals

XLR connector & 1/4" TRS jack 2 sets

MASTER 1 output terminal

XLR connector 1 set

MASTER 2 output terminal

RCA pin jacks 1 set

BOOTH output terminal

1/4" TRS jack 1 set

PHONES output terminal

1/4" stereo jack..... 1 set

3.5 mm stereo mini jack 1 set

USB ports

USB Type-A..... 2 sets

Power supply.....5 V/1 A or less

USB Type-C 1 set

LINK port (PRO DJ LINK)

LAN port (100BASE-TX) 1 set

Wireless LAN section

Supported standards..... IEEE 802.11 a/b/g/n/ac

Frequency band used 2.4 GHz/5 GHz

Bluetooth[®]/MD section

Wireless system..... Bluetooth ver.5.3

Maximum transmission distance..... Approximately 20 m*¹ in unobstructed circumstances.

Frequency band used2.4 GHz

Compatible Codecs..... SBC, AAC

*1 Transmission distances are a guideline. Transmission distance may change depending on the surrounding environment.

SonicLink section

Maximum transmission distance..... Approximately 5 m*2 in unobstructed circumstances.

Frequency band used2.4 GHz

*2 Transmission distances are a guideline. Transmission distance may change depending on the surrounding environment.

We don't guarantee that this unit will connect and operate with all wireless LAN routers and Bluetooth devices.

When using Bluetooth, Wireless LAN (Wi-Fi®), and SonicLink:

To avoid radio wave interference that may occur when using Bluetooth or SonicLink with Wireless LAN (Wi-Fi®) at the same time, turn Wireless LAN (Wi-Fi®) off or set [**Wi-Fi Frequency**] to [**5GHz (Recommended)**] in the Utility Settings.

The specifications and design of this product are subject to change without notice.

Additional information

Troubleshooting

If you think something is wrong with the unit, check the information below and refer to the [FAQ] for the XDJ-AZ at the URL below.

alphatheta.com/support/

- Inspect devices connected with the unit.
- The unit may restore proper operation after you turn it off and on.

If the problems continue, read the Precautions for Use and consult an authorized service company or your dealer.

Error display

❖ E-8302 (Error type: CANNOT PLAY TRACK)

- The unit can't read audio files from the storage device. The audio files may be corrupted. Check if the files can be played with another player that supports files in the formats supported by this unit.

❖ E-8304/E-8305 (Error type: UNSUPPORTED FILE FORMAT)

- The loaded audio file is in a format that isn't supported by this unit. Play an audio file in a format that's supported by this unit (page 11).

Wireless LAN (Wi-Fi®)

❖ The unit can't connect to an access point.

- Check if the network (SSID), password, and encryption method are set correctly. Match the settings on this unit with the network settings.

❖ The access point can't be found.

- If the unit and the wireless router are placed far apart, bring them closer together.
- If there is an obstacle between this unit and the wireless router, remove it.

Bluetooth

❖ The unit can't connect with a Bluetooth device.

- Turn on the unit and the Bluetooth device again, and perform the pairing procedure.

❖ Sound is interrupted.

- If the unit and the Bluetooth device is placed far apart, bring them closer together.
 - If there is an obstacle between this unit and the Bluetooth device, remove it.
-

CloudDirectPlay

❖ Tracks aren't displayed or can't be loaded.

- Tracks aren't displayed on the browse screen if rekordbox for Mac/Windows or rekordbox for iOS/Android hasn't been synchronized with the library in your cloud storage. Wait until the synchronization completes.
- Check if tracks are uploaded to Dropbox/Google Drive.
Only tracks uploaded to Dropbox/Google Drive are displayed on the browse screen. You can't load tracks that haven't been uploaded to Dropbox/Google Drive. Upload tracks to Dropbox/Google Drive using rekordbox for Mac/Windows or rekordbox for iOS/Android beforehand.
- You can't load tracks to the unit when Dropbox/Google Drive is under maintenance or failure occurs in Dropbox/Google Drive. Load them after the maintenance completes or after the issue is fixed.

❖ Not enough space on the USB device.

- When using CloudDirectPlay, tracks loaded from Dropbox/Google Drive are temporarily saved on the connected USB device. Enough free space is needed for saving the loaded tracks on the USB device. The reference file size for a track is as follows (it depends on the length of the track and the file format).
 - mp3 format: 12 MB (for a 6-minute track with 320 kbps)
 - WAV format: 66 MB (for a 6-minute track with CD sound quality)

StreamingDirectPlay

❖ Can't use Beatport Streaming.

- Check the internet connection.

❖ Tracks aren't displayed on the track list

- You need an applicable subscription to use Beatport Streaming.

LCD display

- Small black or shining points may appear on the LCD display. This is a phenomenon inherent to LCD displays and not a malfunction.
- When using the unit in cold places, the LCD display may be dark for a while after the power is turned on. Normal brightness will restore after a while.
- When the LCD display is exposed to direct sunlight, the light will reflect off it, making it difficult to see. Block the direct sunlight to improve visibility of the display.

Cleaning

Wipe with a dry soft cloth.

- Do not use organic solvents, acids or alkalis for cleaning.

Touchscreen

- Operate the touchscreen with your fingertip. Do not press it with excessive force.
- Do not operate the touchscreen with hard and sharp-pointed objects such as a ballpoint pen, mechanical pencil, or sharp fingernail.

Trademarks and registered trademarks

- rekordbox™ is a trademark or registered trademark of AlphaTheta Corporation.
- PRO DJ LINK™ is a trademark or registered trademark of AlphaTheta Corporation.
- Mac, macOS and Finder are trademarks of Apple Inc., registered in the U.S. and other countries and regions.
- Windows is a trademark or registered trademark of Microsoft Corporation in the U.S. and other countries.
- ASIO is a trademark or registered trademark of Steinberg Media Technologies GmbH.
- Serato DJ Pro is a registered trademark of Serato Limited.
- iOS is a trademark containing Cisco trademark signs in the U.S. and other countries.
- Android and Google Drive are trademarks of Google LLC.
- Dropbox is a trademark or registered trademark of Dropbox, Inc.
- Beatport, Beatport Streaming and its logo are trademarks or registered trademarks of Beatport, LLC.
- Wi-Fi is a registered trademark of Wi-Fi Alliance®.
- The Bluetooth®/MD word mark and logos are registered trademarks owned by Bluetooth SIG, Inc. and any use of such marks by AlphaTheta Corporation is under license. Other trademarks and trade names are those of their respective owners.

Other product, technology and company names, etc. mentioned herein are trademarks or registered trademarks of their respective owners.

About using MP3 files

This product has been licensed for nonprofit use. This product has not been licensed for commercial purposes (for profit-making use), such as broadcasting (terrestrial, satellite, cable or other types of broadcasting), streaming on the Internet, Intranet (a corporate network) or other types of networks or distributing of electronic information (online digital music distribution service). You need to acquire the corresponding licenses for such uses. For details, see <http://www.mp3licensing.com>.

Cautions on copyrights

rekordbox restricts playback and duplication of copyright-protected music contents.

- When coded data, etc., for protecting the copyright is embedded in the music contents, it may not be possible to operate the program normally.
- When rekordbox detects that coded data, etc., for protecting the copyright is embedded in the music contents, processing (playback, reading, etc.) may stop.

Recordings you have made are for your personal enjoyment and according to copyright laws may not be used without the consent of the copyright holder.

- Music recorded from CDs, etc., is protected by the copyright laws of individual countries and by international treaties. It is the full responsibility of the person who has recorded the music to ensure that it is used legally.
- When handling music downloaded from the Internet, etc., it is the full responsibility of the person who has downloaded the music to ensure that it is used in accordance with the contract concluded with the download site.

The specifications and design of this product are subject to change without notice.

© 2024 AlphaTheta Corporation. All rights reserved.

<DRI1936-A>