

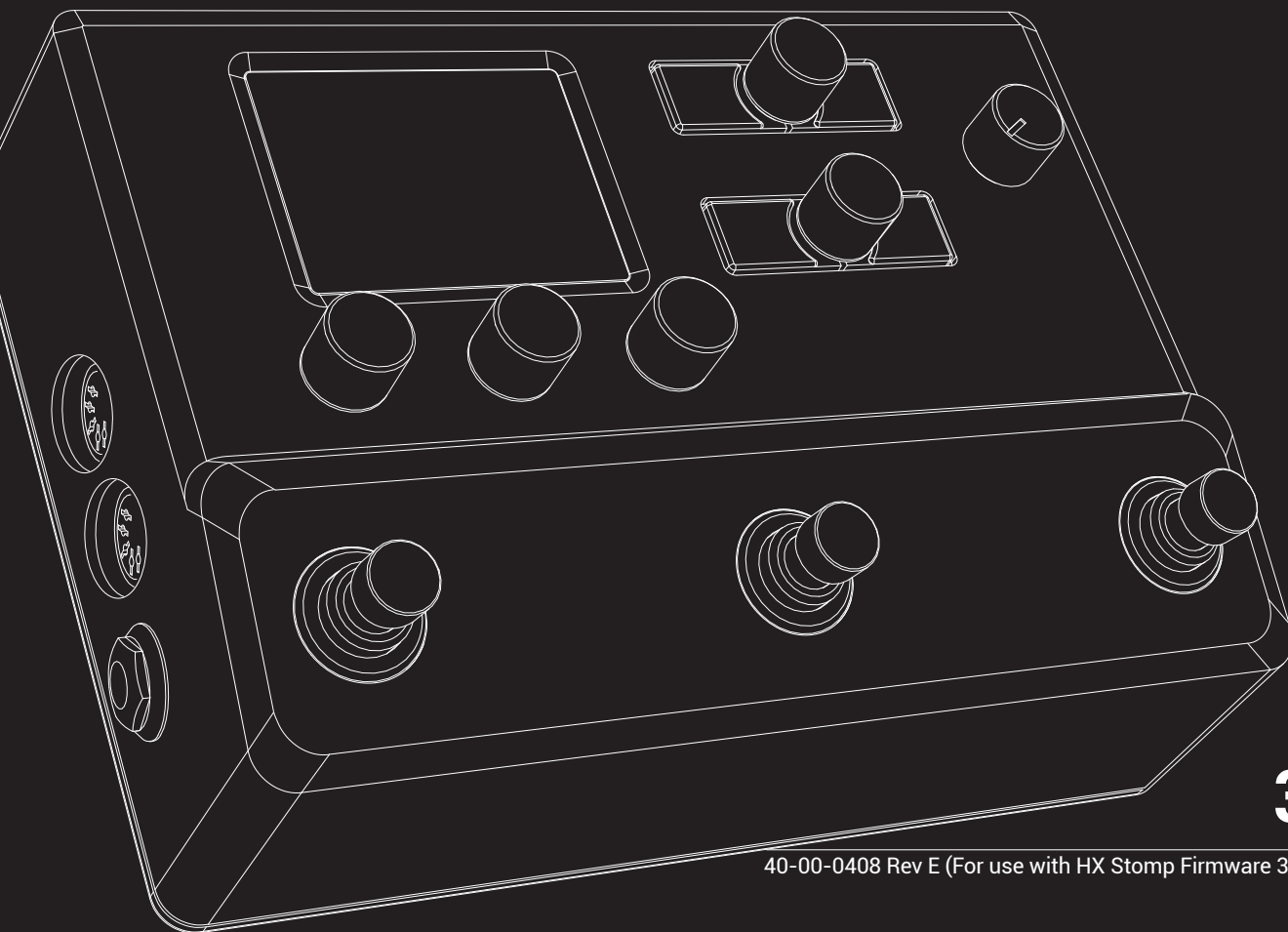

HX STOMP



3.0 OWNER'S MANUAL >

40-00-0408 Rev E (For use with HX Stomp Firmware 3.00)

© 2024 Yamaha Guitar Group, Inc. All rights reserved.

Contents

Welcome to HX Stomp

What's In the Box?	4
Common Terminology	4
HX Edit Application	5
Updating HX Stomp Firmware	5
Marketplace	5
The Hardware	6

Quick Start

Hooking It All Up	9
Play View	12
Selecting a Preset	12
Preset List	13
Edit View	13
Selecting Blocks/Adjusting Parameters	13
Bypassing a Block	14
Bypassing HX Stomp Completely	14
Choosing a Block's Model	14
Moving Blocks	15
Copying/Pasting a Block	15
Clearing a Block	15
Clearing All Blocks	16
Adding a Block to Favorites	16
Saving a Model's Default Settings	17
Saving/Naming a Preset	17
Creating/Restoring Full Device Backups	17
Serial vs. Parallel Routing	18
Setting Path B's Output	18
TAP Tempo	19
The Tuner	19
Dynamic DSP	20
Block Order and Stereo Imaging	21

4 The Blocks

Input	22
Outputs	22
Signal Present and Clip Indicators	23
Effects	23
Amp+Cab	29
Amp	31
Preamp	31
Cab	31
Impulse Response (IR)	32
Send/Return	33
Looper	34
Split	35
Mixer	36
U.S. Registered Trademarks	37

38 Snapshots

Using Snapshots	38
Snapshot Block Bypass On/Off	39
Copying/Pasting a Snapshot	39
Swapping Snapshots	40
Saving Snapshots	40
Determining Snapshot Edit Behavior	40

41 Bypass Assign

Quick Footswitch Assign	41
Manual Bypass Assign	41
Clearing Bypass Assignments	42
Clearing All Bypass Assignments	42
Swapping Stomp Footswitches	42

43 Controller Assign

Assigning a Controller	43
Clearing a Block's Controller Assignment(s)	44
Clearing All Controller Assignments	44

22 Command Center

Assigning a Command	45
Copying and Pasting a Command	48
Copying and Pasting All Commands	48
Clearing a Command	48
Clearing All Commands	48

49 Global EQ

Resetting Global EQ	49
---------------------	----

50 Global Settings

Setting Proper Levels	50
Resetting All Global Settings	50
Global Settings > Ins/Outs	51
Global Settings > Preferences	52
Global Settings > Footswitches	53
Global Settings > EXP Pedals	54
Global Settings > MIDI/Tempo	54
Global Settings > Displays	54

55 USB Audio

Hardware Monitoring vs. DAW Software Monitoring	55
DI Recording and Re-amping	56
Core Audio Driver Settings (macOS only)	57
ASIO Driver Settings (Windows only)	57

59 MIDI

Preset and Snapshot Recall via MIDI	59
Block Bypass via MIDI	59
Parameter Control via MIDI	59
Synchronizing Tempo via MIDI	60
MIDI CC	60

62 Additional Resources

**Supplier's Declaration of Conformity
47 CFR § 2.1077 Compliance Information**

Unique Identifier: Line 6® HX Stomp™

Responsible Party - U.S. Contact Information:

Yamaha Guitar Group, Inc.
26580 Agoura Road
Calabasas, CA 91302-1921
(818) 575-3600
<https://line6.com/>

FCC Compliance Statement:

This device complies with Part 15 of the FCC Rules. Operation is subject to the following two conditions: (1) This device may not cause harmful interference, and (2) this device must accept any interference received, including interference that may cause undesired operation.

© 2024 Yamaha Guitar Group, Inc. All rights reserved.

Line 6, the Line 6 logo, Helix, HX, M13, M9, M5, DL4, DM4, MM4, FM4, POD, Powercab, Ampeg, SVT, and Portaflex are trademarks or registered trademarks of Yamaha Guitar Group, Inc. in the U.S. and/or other jurisdictions. Apple, Mac, macOS, iPad, iPhone, and iTunes are trademarks of Apple, Inc. registered in the U.S. and other countries. Apple is not responsible for the operation of this device or its compliance with safety and regulatory standards. Windows is a registered trademark of Microsoft Corporation in the United States and/or other countries. YouTube is a trademark of Google, Inc.

The Model and Serial numbers can be found on the product label. Please record these numbers below and retain this document for your records.

Model Number: _____

Serial Number: _____

Welcome to HX Stomp

“60 pages for a pedal? Man, I hate reading manuals!”

I know, right?! We're not overly fond of writing them either, especially when so few people read them. What if we make a handful of super-short videos that get you up and running with HX Stomp™ in minutes, and you promise not to jump online and complain about having to read a lengthy manual for a pedal. Agreed?

Go here, line6.com/meet-hx-stomp:



“Wheee! I love reading manuals!”

That sounds a bit sarcastic, but regardless, thank you for buying the Line 6® HX Stomp pedal, one of the most powerful and flexible stompboxes ever created. We hope it helps drive your search for tonal bliss and spawns years of creativity, both on stage and in the studio.

Although you're likely anxious to rip open the plastic and plug in, wait! At the very least, check out the *HX Stomp Cheat Sheet* that came in the box, and keep it handy. Then read the “[Quick Start](#)” chapter of this manual, and we'll have you up and shredding in no time.



IMPORTANT! Because the HX Stomp pedal can be used in so many ways, its factory presets are sort of all over the map. For example, any presets starting with “FX” denote tones designed with effects only, for going straight into your guitar amp. Any presets starting with “DIR” denote tones with amp, cab/IR, and effects blocks for going direct into a full-range amplification system like FRFR (Full Range Flat Response) or PA speakers. Also, note that presets starting with “4CM” won't sound at all unless your HX Stomp pedal is connected to your amp via 4-Cable Method - see [page 9](#).

What's In the Box?

- Line 6® HX Stomp™ multi-effects pedal
- *HX Stomp Cheat Sheet* (read that one first!)
- AC power adapter
- USB cable
- Warranty card

Common Terminology

While reading this manual, you may encounter several unfamiliar terms. It's important to know what they mean. Be careful—we might toss a pop quiz your way.

Block *Blocks* are objects that represent various elements of your tone, such as amps, cabs, effects, splits, loopers, inputs, outputs, and impulse responses. The HX Stomp pedal can accommodate up to eight simultaneous amp, cab, IR, effects, and/or looper blocks, DSP permitting.

Model Each processing block can accommodate one *model* (or, in some cases, two models). HX Stomp includes over 80 guitar and bass amps, over 40 cabs, and over 220 effects models.

Preset A *preset* is your tone. It consists of all blocks, snapshots, footswitch assignments, and controller assignments.

Controller *Controllers* are used to adjust various parameters in real-time. For example, an external expression pedal can be used to control wah, or the mod wheel on your MIDI keyboard can be used to control delay feedback and reverb depth.

Send/Return The HX Stomp stereo TRS *Send* and separate left and right *Returns* are used to insert your favorite stompboxes anywhere in the signal flow or for connecting to your guitar amp via 4-Cable Method - see [page 9](#).

IR *IRs* (Impulse Responses) are mathematical functions representing the sonic measurements of audio systems. HX Stomp can store up to 128 custom or third-party IRs at a time. See “[Impulse Response \(IR\)](#)”



***NOTE:** To import IRs into your HX Stomp hardware, you'll need to download and install the latest Line 6 HX Edit software—see the following “[HX Edit Application](#)” section.

Why Does HX Stomp Sound [insert descriptor here]?

Like most guitarists, you're probably used to the sound and feel of real tube amps. So are we. Musicians instinctually understand that a roaring 4x12 cab pointing at the back of their knees sounds and feels totally different from a pair of plastic PA speakers (or even high-quality studio monitors) pointing at their face. Yet some may blame their multieffects box for this disparity. Like any other device without built-in speakers, HX Stomp is completely at the mercy of what you plug it into. Your playback system has a massive impact on the sound and feel of your tone, and if HX Stomp appears to sound thin, tubby, boxy, harsh, dull, or some other less-than-ideal adjective, the first thing to scrutinize is your playback system.

There's also nothing wrong with bypassing the HX Stomp cab or IR blocks and running it into a flat power amp and real wooden cab; digital magic will never convince anyone their six-inch computer speakers are a wall o' stacks. Your tone is only as good as the weakest link in your chain, and understand that given identical playback systems, HX Stomp amp modeling is designed to be virtually indistinguishable from the real thing.

HX Edit Application



Be sure to grab the free **HX Edit** application for Mac and PC—available for download at line6.com/software.

HX Edit is a full-featured editor and preset & IR librarian, and allows you to easily create & restore full HX Stomp device backups, as well as update your device to the latest firmware (also see next section). You can connect more than one Helix and/or HX device, and HX Edit will display an individual application window for each.

Preset Sharing with Helix/HX Devices & Helix Native Plugin

All Helix and HX hardware and software live within the same ecosystem. Using multiple device windows within HX Edit and/or multiple instances of the Helix Native plugin, both blocks and entire presets can be freely dragged and dropped or copied and pasted between units, with some restrictions. Please see the HX Edit and Helix Native [Pilot's Guides](#) for specifics on preset compatibility.

Updating HX Stomp Firmware

If your HX Stomp device is still running a previous firmware version, it is highly recommended to update to v3.0 (or the latest available version), which can be accomplished easily using the Line 6 HX Edit application!

! IMPORTANT! As of firmware version 3.0, the HX Stomp device's maximum block count has been increased from six to eight blocks! All earlier HX Stomp presets are still fully compatible with HX Stomp 3.0. **Please note, however, that presets saved using HX Stomp 3.0 (or later) are not compatible with HX Stomp version 2.xx firmware.** We recommend using HX Edit to back up all your v2.xx-created presets *before* updating to firmware v3.0.

First, install the latest HX Edit software version on your Mac or PC (available at line6.com/software), connect HX Stomp to your computer's USB port, and HX Edit will check online and let you know if a newer firmware version is available. If so, HX Edit will then walk you through performing a full device backup and firmware update, all within minutes. Please see the [HX Edit Pilot's Guide](#) for full details.

Marketplace

Be sure to visit the [Line 6 Marketplace online shop](#), where you'll find 3rd-party add-on assets that further enhance the functionality of Helix and HX devices and Helix Native plugin! As of this writing, 3rd-party presets and IRs are available—check back often on Marketplace for product news and announcements.





You can access Marketplace directly using the free [HX Edit app](#), where you sign in to your Line 6 online account, then choose to **Get More Presets** or **Get More IRs** from the HX Edit menu. Once you've purchased premium Marketplace assets, they can be downloaded immediately, directly into your HX Edit Presets and/or IR Library, and ready to use on HX Stomp! Please see the latest [HX Edit Pilot's Guide](#) for details.





TIP: Registered owners of Line 6 Helix/HX family devices are entitled to a generous discount toward the purchase of the **Helix Native plugin!** Note that all your HX Stomp presets and IRs can be loaded directly into Helix Native—making your stage and studio tasks easier than ever! Please visit the [Line 6 Online Shop](#).







The Hardware





1. **Main Display** This color LCD is your window into the power of HX Stomp.
2.  **VIEW** If you ever get lost, press this button to return home. Press  again to toggle between the two main Home views—see [“Play View”](#) and [“Edit View”](#).
3. **ACTION** Press this button to open the action panel for the selected block or menu. From Edit view, the action panel lets you move, copy, paste, and clear blocks, as well as add any changes you've made to a block as a Favorite or save it as a model default. Other menus may have unique action panels; for example, the Global Settings action panel lets you reset all global settings at once.

Press  and ACTION together to open the Save menu for renaming and saving changes to a preset. Press both buttons twice to quick save. See [“Saving/Naming a Preset”](#).
4. **Upper Knob** In Play view, turn this knob to select a preset. Press this knob to open the preset list. In Edit view, turn this knob to select a block for editing. Press this knob to bypass/enable the selected block.
5. **Lower Knob** In Edit view, turn this knob to change the current block's model. Press this knob to open the model list. See [“Choosing a Block's Model”](#).

 **TIP:** Press the Upper Knob and Lower Knob together to bypass HX Stomp completely. The display will read “Analog [or DSP] bypass! Press any switch.”

6.  **PAGE/PAGE**  In Play view, press  PAGE or PAGE  to change footswitch modes. In Edit view, press to view more parameters for the selected block or menu. Press both  PAGE and PAGE  to dive deeper into HX Stomp, and you'll find Controller Assign, Global Settings, and other menus.
7. **VOLUME** Turn this knob to control the main output and headphones volume.
8. **Knobs 1-3** In Edit view, turn one of the three knobs below the main display to adjust the parameter's value above; press the knob to reset the parameter's value. If a rectangular button appears above a knob, press the knob to engage its function.

 **SHORTCUT:** For most time-based parameters such as delay time or modulation speed, press the knob to toggle between setting the value in ms or Hz and note divisions (1/4-note, dotted 1/8-note, etc.).

 **SHORTCUT:** Controllers can be assigned to most parameters. Press and hold a parameter's knob to quickly jump to the [“Controller Assign”](#) page for that parameter. Press and turn a parameter's knob to quickly assign it to be controlled via [“Snapshots”](#).

9. **Footswitches 1-3** These capacitive, touch-sensitive footswitches have colored LED rings that indicate assigned block's current state or function. See [“Play View”](#) for more information.



SHORTCUTS: While in Stomp footswitch mode and the Edit view screen, touch (but don't press) a footswitch for two seconds to create a Bypass Assignment for the selected block.

While in Stomp footswitch mode, touch and hold (but don't press) two switches to swap all assignments between them.

While in Stomp or Scroll footswitch modes, touch (but don't press) TAP to display the tempo panel briefly. This lets you quickly fine-tune the current tempo.

Touch-to-select can optionally be turned off, and other footswitch settings customized - See [“Global Settings > Footswitches”](#)

10. **EXP 1/2, FS 4/5** Connect an expression pedal here to adjust a wide variety of parameters.* With a Y-cable (tip-ring-sleeve 1/4" jack, split to two tip-sleeve 1/4" jacks), two expression pedals can be connected. Alternatively, you can add one (or with a Y-cable, two) external footswitches to access additional stomps, presets, snapshots, etc. (FS4=tip, FS5=ring). To set this jack's function(s), see [page 52](#). By default, this jack is set to accommodate a [Mission SP1-L6H Line 6 Expression Pedal](#), which has a toe switch that toggles between EXP 1 (Wah/Pitch or Poly Wham) and EXP 2 (Volume/Pan). For external footswitches, the momentary (unlatched) type should be used.



***NOTE:** It is recommended to connect to this EXP1/2, FS 4/5 input while the device is powered off to avoid toggling the current FS 4/5 setting.

11. **INPUT L/MONO, RIGHT** Connect your guitar, bass guitar, or mono pedals to the L/MONO input. Connect stereo pedals, keyboards, synths, or modelers to both the L/MONO and RIGHT inputs.
12. **OUTPUT L/MONO, RIGHT** These 1/4" outputs can accommodate either unbalanced TS cables to connect to your guitar amp or other pedals or balanced TRS cables to connect to your mixing console or studio monitors. When connecting to a mono pedal or single amp, connect only the L/MONO 1/4" jack.
13. **USB** HX Stomp also functions as a high quality multichannel 24-bit/96kHz audio interface for Mac and Windows computers, with DI, re-amping, and MIDI functionality built right in. Use of a USB 2.0 (or higher) port is required—do not use an external USB hub. HX Stomp can also record to an Apple iPad or iPhone mobile device (with optional Apple Camera Connection Kit).

14. DC In Line 6 recommends using only the included power supply, since the HX Stomp packs a lot of circuitry into its tiny housing. That said, Line 6 has provided a list of third-party supplies that we've tested with HX Stomp, which can be found here: <https://line6.com/support/page/kb/effects-controllers/>. The provided AC adapter serves as the disconnect device.

15. Power Switch Nine out of ten blues dentists agree: HX Stomp is more fun when powered on. The tenth dentist is a nihilist.

16. MIDI IN, OUT/THRU Connect HX Stomp to your MIDI gear to send and receive program changes, continuous controllers, and other MIDI messages. See "[MIDI](#)" for more information.

17. Phones Out Connect stereo headphones here; turn the VOLUME knob to adjust the volume.

 **IMPORTANT!** Always turn the VOLUME knob down before connecting headphones. Protect your hearing!
"What?!"
I said... ALWAYS TURN THE VOLUME KNOB DOWN BEFORE CONNECTING HEADPHONES. PROTECT YOUR HEARING!

18. SENDS/RETURNS L/R These 1/4" ins and outs can be used as an FX loop for inserting external stompboxes between specific blocks in HX Stomp or as inputs and outputs for running 4-Cable Method rigs. See "[HX Stomp in 4-Cable Method](#)". Alternatively, the L/MONO and RIGHT inputs can act as an always-on Aux In for monitoring mixers, keyboards, drum machines, or MP3 players. To set the function of the Return L/R jacks, see "[Global Settings > Ins/Outs](#)".

Quick Start

Hooking It All Up

There are many ways to connect HX Stomp to other gear, and the following pages illustrate only a few.

HX Stomp on a Pedalboard

Although HX Stomp has amp and cab modeling, there's no reason you *have* to use it, especially if you have a favorite guitar or bass amp. All eight processing blocks can be dedicated to effects and effects control.

TIP. Look for factory presets with names starting with "FX." These have been created with effects blocks only.

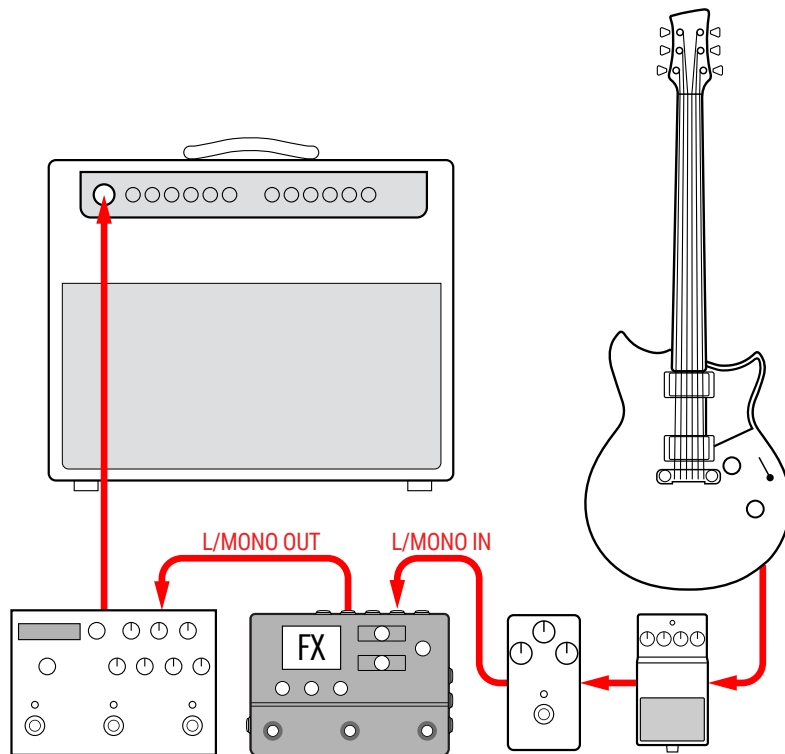

HX Stomp in 4-Cable Method

"4 Cable-Method" is a popular and flexible way of hooking things up, allowing you to route some effects blocks (most often drives, distortions, wahs, and compressors) before your amp's preamp and other effects blocks (often time-based effects like delays and reverbs) in its effects loop.

NOTE: The effects loops on most amplifiers run at instrument level. If your amp's effects loop happens to run at line level, you should set the inputs and outputs of HX Stomp to line level as well. See "[Setting Proper Levels](#)".

IMPORTANT! Make sure you add a Send/Return > Mono > FX Loop block at the point in your signal flow where you wish your amp's preamp to be. Otherwise you won't hear anything.

TIP. Look for factory presets starting with "4CM." Note that these presets will not pass any audio unless hooked up in the method below!

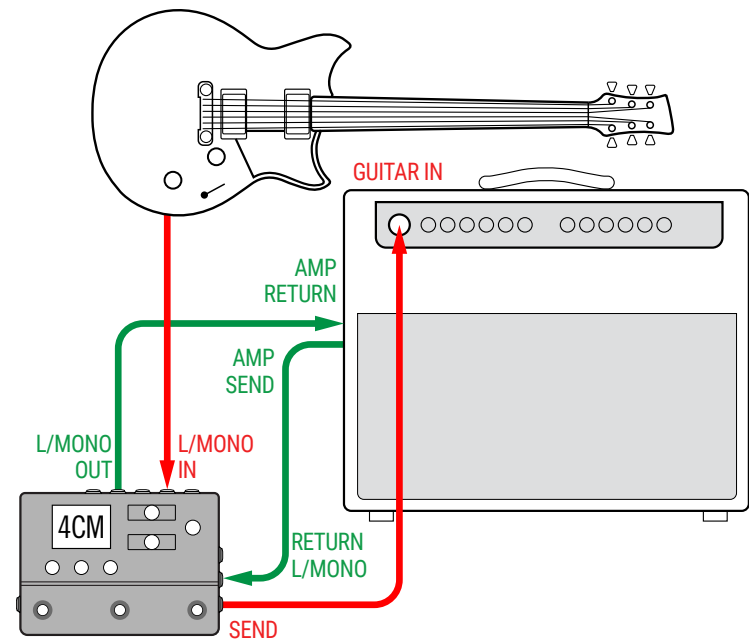

HX Stomp with Powered Speakers

Depending on how complex your tones are, HX Stomp may be able to act as your entire processing rig, providing amp modeling, cab modeling, or cab IRs (Impulse Responses), effects, looping, and even a tuner.

When connecting HX Stomp to a powered speaker (or two powered speakers in stereo), set the main outputs to line level. See [“Setting Proper Levels”](#).

TIP: Be sure to check out the [Line 6 Powercab®](#) active guitar speaker systems—designed specifically for use with modelers like HX Stomp!

You can connect up to two expression pedals and/or momentary type footswitches to HX Stomp’s rear panel **EXP 1/2 | FS 4/5** jack using a Y cable. Alternatively, you can connect a single [Mission SP1-L6H Line 6 Expression Pedal](#), which has a toe switch built in that can toggle its function between EXP 1 (Wah by default) and EXP 2 (Volume by default).

TIP: Look for factory presets starting with “DIR” (short for direct). These have been created with a full tone’s worth of amps, cabs, and effects.

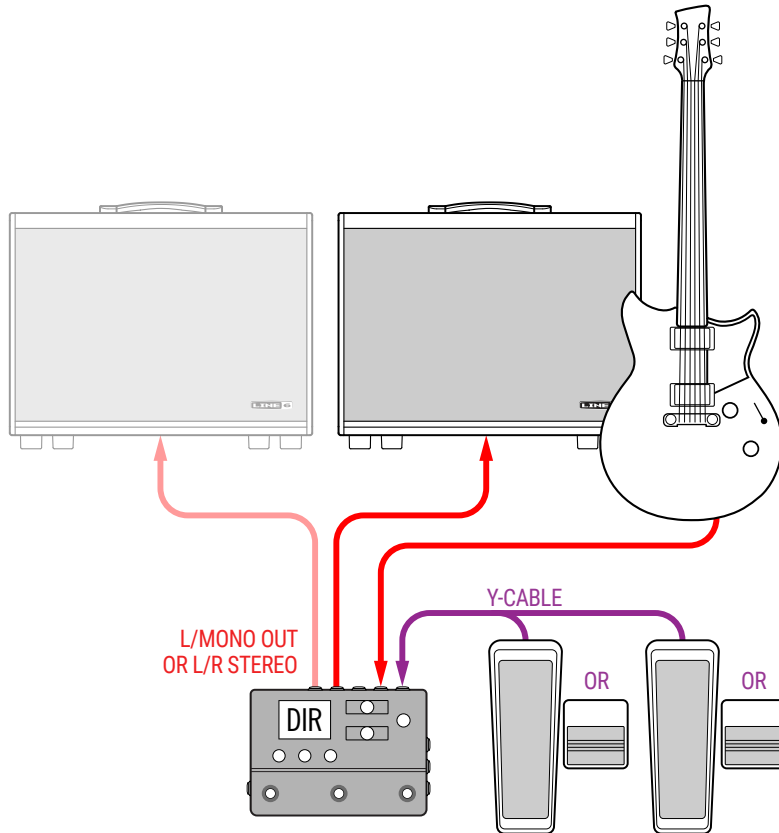

HX Stomp in a Hybrid Amp/Direct Setup

When playing live, some guitarists and bassists love running their signal direct to the FOH (Front of House) console but prefer the feel of standing in front of a real amp. HX Stomp can accommodate both playback systems simultaneously.

Place a Send/Return > Mono > Send L block directly before any Amp or Amp+Cab block in your signal flow. This will be the point where the signal is tapped and sent to your real amp. Then the full signal flow with Amp and Cab/IR blocks can be sent to the FOH console.

TIP: Look for factory presets starting with “BAS.” These have been created with a Send/Return > Mono > Send L block positioned after Effects blocks and before the Amp or Amp+Cab block. Although they’ve been designed with bass players in mind, there’s nothing wrong with swapping out the bass amp and cab for a guitar amp and cab (or IR).

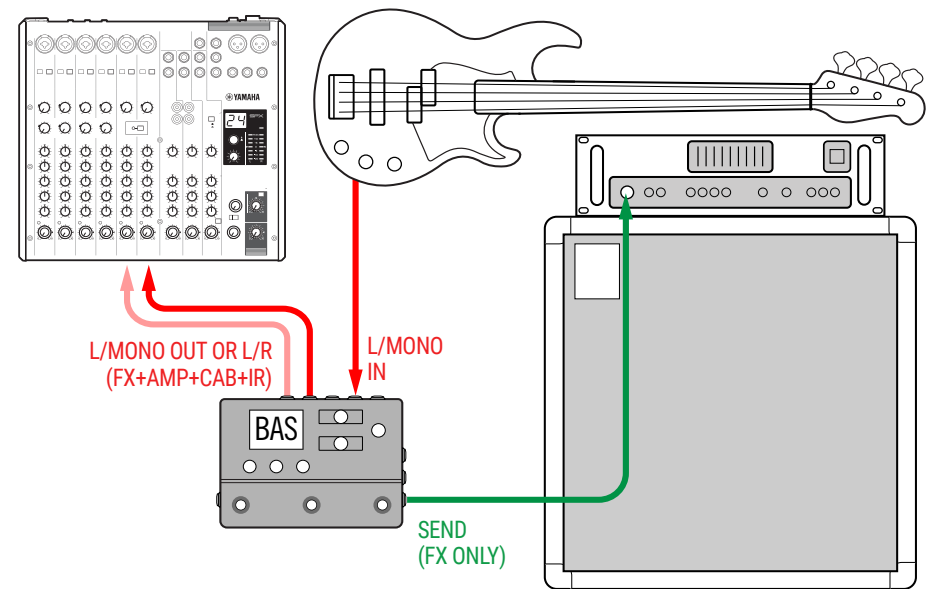

HX Stomp as DSP Expansion

Let's face it—there are a lot of great digital guitar products out there, and maybe you just can't part with your favorite box. But maybe you're also a bit curious about HX amp modeling and effects. Decisions, decisions.

Fortunately, you can have both. If you place HX Stomp in the stereo effects loop of your favorite modeler or profiler, it's like instantly adding dozens of amps and a few hundred effects to your existing arsenal. Plus, the eight processing blocks in HX Stomp are utilized in addition to your modeler's DSP, so you get more *simultaneous* amps and effects.* You may even be able to synchronize presets and tempi between the two with a single MIDI cable; see your modeler's documentation for more information.

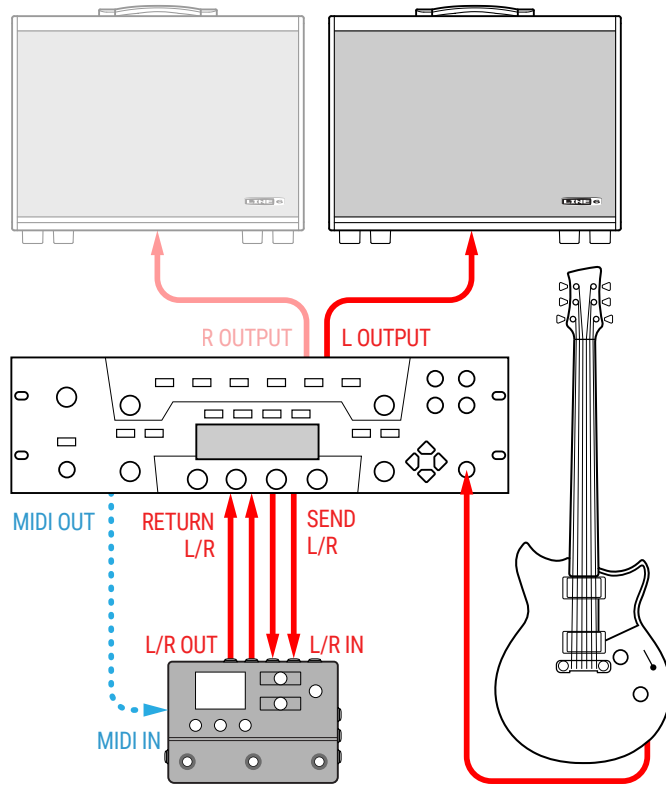

***NOTE:** As of firmware version 3.0, HX Stomp includes support for up to eight blocks within a preset! Previous HX Stomp firmware versions support only up to six blocks.

HX Stomp in the Studio

HX Stomp also includes a multichannel USB audio/MIDI interface for your production studio, with professional-quality A/D/A conversion, 123dB of dynamic range, and a programmable impedance circuit. This makes it the perfect front end for the [Helix Native plugin](#).

If you aren't using Helix Native, HX Stomp can *re-amp* or use USB audio streams to process tracks or busses in your DAW (Digital Audio Workstation) after they're recorded. See "[USB Audio](#)" for more information.

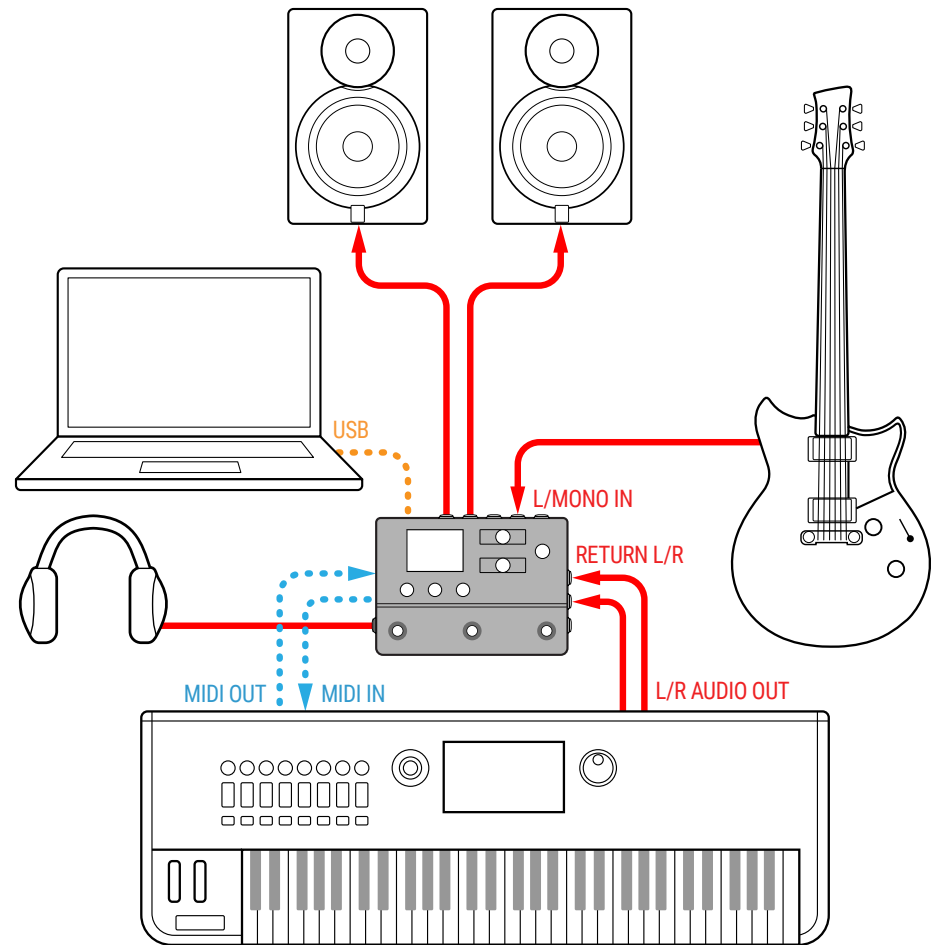

Play View

HX Stomp has two main views—Play view and Edit view. Play view is typically used when performing or jamming.

1. Press VIEW to select Play view.

The current preset number and name appear on the upper half of the display, and the current footswitch mode's assignments appear on the lower half:

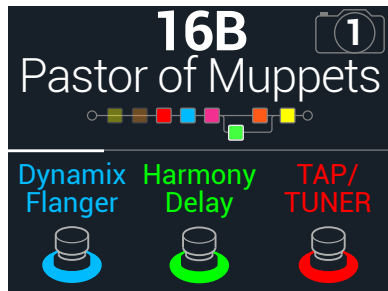

2. Press PAGE or PAGE to select one of four footswitch modes (see below).

Selecting a Preset

HX Stomp stores 42 banks of three presets (A, B, and C) for a total of 126 presets.

1. If not already there, press VIEW to select Play view.
2. Press PAGE or PAGE to select Preset Mode (see below).
3. Press FS1+FS2 (or FS2+FS3) to choose the desired bank.

The bank's presets flash, indicating they are ready to load:

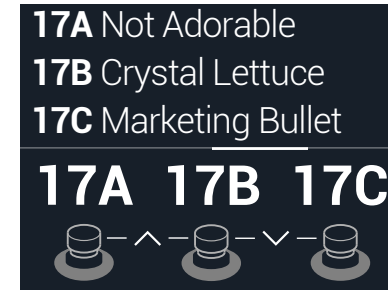

4. Press one of the footswitches to load its preset.
Alternatively, turn the Upper Knob to select a preset.

Stomp Mode

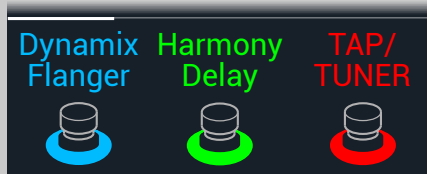

Step on FS1/FS2 to turn any assigned block(s) on and off.

Touch FS1 or FS2 repeatedly to view additional assignments, if any.

Step on FS3 to set the tempo.

Hold FS3 to open the tuner.

Touch FS3 to open the tempo panel.

Scroll Mode



Step on FS1 to select the previous preset.

Step on FS2 to select the next preset.

Hold FS1+FS2 to toggle between Preset Up/Down and Snapshot Up/Down

Step on FS3 to set the tempo.

Hold FS3 to open the tuner.

Touch FS3 to open the tempo panel.

Preset Mode



Step on a footswitch to select a preset (A, B, or C).

Step on FS1+FS2 to queue the previous bank of presets.

Step on FS2+FS3 to queue the next bank of presets.

Snapshot Mode



Step on a footswitch to select Snapshot 1, 2, or 3.

Step on FS1+FS2 to queue the previous bank of presets.

Step on FS2+FS3 to queue the next bank of presets.

See "[Snapshots](#)" for more information.

Preset List

1. If not already there, press **VIEW** to select Play view.
2. Press the Upper Knob to open the Preset list:

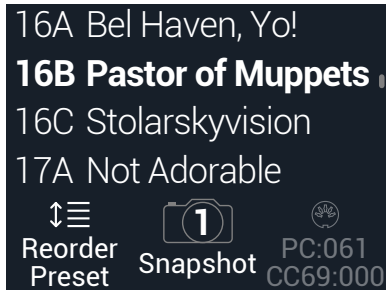

Turn the Upper Knob to select a preset.

Turn Knob 1 (Reorder Preset) to move the selected preset up and down the list.

Turn Knob 2 (Snapshot) to select Snapshot 1, 2, or 3 without having to be in Snapshot footswitch mode. See "[Snapshots](#)" for more information.

TIP: The grayed-out numbers above Knob 3 represent the messages required to recall the current preset (PC:XXX) and snapshot (CC69:XXX) from an external MIDI controller or sequencing software.

Edit View

HX Stomp has two main views—Play view and Edit view. Edit view is used for creating or tweaking your tones.

Press **VIEW** to select Edit view.

Colored blocks representing amps, cabs, effects, and other items appear on the upper half of the display, and the selected block's parameters appear on the lower half:

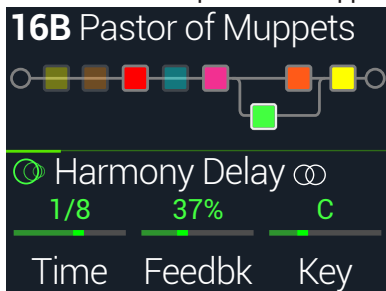

Selecting Blocks/Adjusting Parameters

Each preset in HX Stomp can accommodate up to eight *blocks*. Blocks are objects that represent various elements of a preset, such as amps, cabs, effects, or even a 1 Switch Looper. In addition to the eight processing blocks, each preset has an Input block, Output block, and for presets with two parallel paths, Split and Mixer blocks.

1. While in Edit view, from Stomp footswitch mode, briefly touch (but don't press) the footswitch assigned to the block (if any).

If multiple blocks are assigned to a footswitch, touch the top of the switch repeatedly until the desired block is selected.

Alternatively, turn the Upper Knob to select blocks.

The selected block appears with a white outline:



2. Turn Knobs 1-3 below the screen.

Some blocks have more than one page of parameters. In this case, the center inspector line will display a thin colored scroll bar:



3. Press **PAGE** or **PAGE** to access more parameters (if available).



SHORTCUT: For most time-based parameters such as delay time or modulation speed, press the knob to toggle between setting the value in ms or Hz and note divisions (1/4-note, dotted 1/8-note, etc.).

Bypassing a Block

1. If not already there, press VIEW to select Edit view.
2. Turn the Upper Knob to select a block and then press it to toggle the block on and off.

A bypassed block appears semi-transparent and, if assigned to a Stomp mode footswitch, its LED ring dims:



Bypassing HX Stomp Completely

1. Press the Upper Knob and Lower Knob together.

While HX Stomp is completely bypassed, the inspector displays the following:

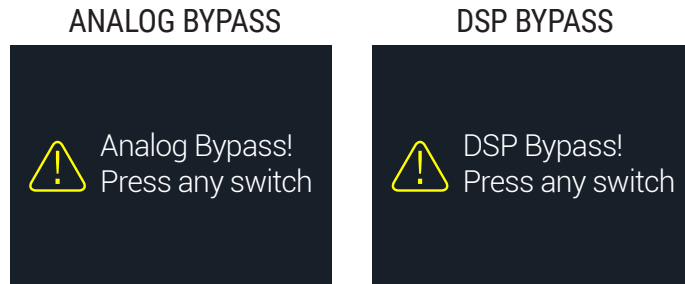

NOTE: There are two types of All Bypass in HX Stomp: Analog bypass (sometimes called “true bypass”), where mechanically switching relays route your signal directly from the inputs to the outputs with no processing or A/D/A conversion, and DSP bypass, where any delay echoes and reverb tails decay naturally. By default, HX Stomp is set for Analog bypass, but this behavior can be set from [“Global Settings > Preferences”](#).

2. Press any footswitch.

HX Stomp returns to normal operation.

TIP: You can also re-purpose the TAP/TUNER switch (or external footswitch FS4 or FS5) to All Bypass. See [“Global Settings > Footswitches”](#).

Choosing a Block’s Model

1. If not already there, press VIEW to select Edit view.
2. Turn the Upper Knob to select the desired block, then turn the Lower Knob to change its model.

To create a new block, turn the Upper Knob to select an empty location and then turn the Lower Knob.

Selecting models within the same category can be very quick. However, as HX Stomp has hundreds of items to choose from, using this method to, say, change a mono distortion block (beginning of the list) into a 1 Switch Looper block (end of the list) is very slow. Instead, you should open the model list:

3. Press the Lower Knob to open the model list:

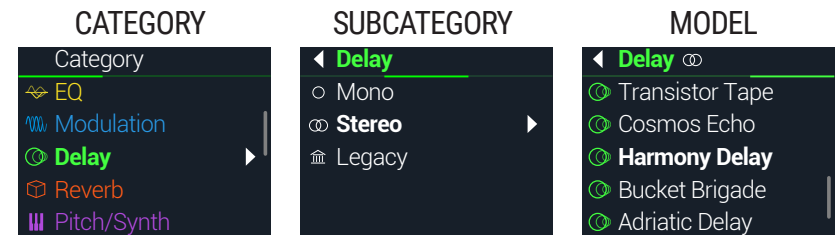

Most model categories include subcategories. For example, effects in the “Mono” and “Stereo” subcategories are HX (Helix) models. Effects in the “Legacy” subcategory are taken from the classic Line 6 M13®, M9®, M5®, DL4™, MM4™, FM4™, and DM4™ pedals. Amp+Cab and Amp models have Guitar and Bass subcategories. Cab models have Single and Dual subcategories.

NOTE: The first category in the list, Favorites, is initially empty, awaiting you to add amp, cab, and/or effects models, including your own custom settings and assignments—see [“Adding a Block to Favorites” on page 16](#).

Turn the Lower Knob to select items in a list.

Press the Lower Knob (or PAGE) to view a category or subcategory’s contents.

Press PAGE to go back one level.

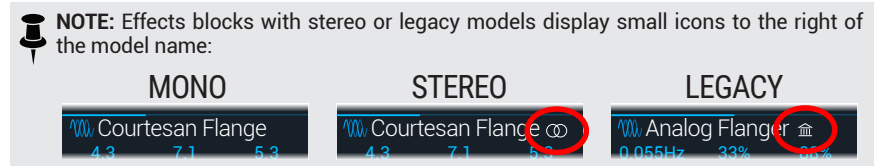



IMPORTANT! If you encounter items in the list that are grayed out or unavailable, this means the preset cannot accommodate that category, subcategory, or model. See ["Dynamic DSP"](#).

- Using the Lower Knob, \triangleleft PAGE, and PAGE \triangleright , select the desired category, subcategory, and model.



SHORTCUT: To quickly skip through model subcategories, without ever having to open the model list—From Edit view, press and turn the Lower Knob to skip subcategories, then turn normally to select models within that subcategory.

- To close the model list, select an item in the far right column and press the Lower Knob again (or press HOME to cancel).

Moving Blocks

- If not already there, press VIEW to select Edit view.
- Turn the Upper Knob to select any block (other than Input or Output) and press ACTION.

The block appears "picked up," and the action panel appears.

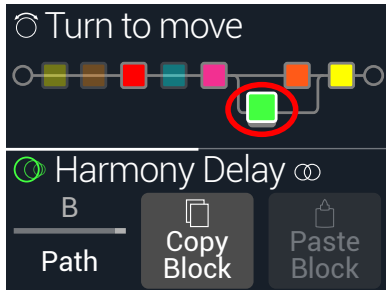

- Turn the Upper Knob to move the block.
- Press ACTION again (or HOME) to close the action panel.



NOTE: To move a block between parallel paths A and B, press ACTION and then turn Knob 1 - See ["Serial vs. Parallel Routing"](#).

Copying/Pasting a Block

Blocks can be copied and then pasted onto either another block location, or into an entirely different preset.

- From Edit view, select the block you wish to copy and press ACTION.
- Press Knob 2 (Copy Block).
- Select the location you wish to paste the block—even in a location within different preset—and press ACTION.
- Press Knob 3 (Paste Block).



NOTE: Inputs, Outputs, Splits, Mixers, and Loopers can also be copied and pasted, where permitted. If you, for example, try pasting the Looper into the Split block's location, Knob 2 (Paste Block) will be grayed out. Furthermore, if the destination preset cannot accommodate the copied block, the header will briefly read "DSP full!" See ["Dynamic DSP"](#).



Clearing a Block

- From Edit view, select the block you wish to clear and press ACTION.
- Press PAGE \triangleright and press Knob 1 (Clear Block).

Clearing All Blocks

Clearing all blocks removes all processing blocks and resets the signal flow to serial. It does not affect the Input and Output blocks.

1. Press **ACTION**.
2. Press **PAGE ▸** and press **Knob 2 (Clear All Blocks)**.

The following dialog appears:

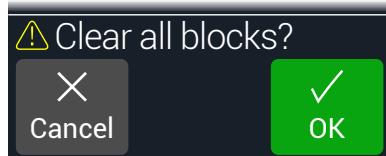

3. Press **Knob 3 (OK)**.

TIP: To retain your changes, remember to **Save** after making edits before switching to a different preset (see next section). Once a preset change is made, all edited settings in an unsaved preset are discarded.

Adding a Block to Favorites

Once you've dialed in an amp or effects block exactly the way you like it, you can save it as a "Favorite" so the block can be added very quickly to other tones, complete with your stored parameter settings and customized bypass assignment (excluding any existing controller and snapshot assignments).

Favorites appear in the model menu's "Favorites" category and can be renamed, reordered, and cleared. You can add up to 128 Favorites.

***NOTE:** If you don't want a favorite to be recalled with a fixed bypass assignment, add the block to Favorites *before* creating a custom bypass assignment. Input, Output, Split, and Merge Mixer block types cannot be added to Favorites.

1. From the **Edit view screen**, choose one of your preferred amps or effects and tweak it exactly how you like it, with or without footswitch and controller assignments.
2. Press **ACTION**, press **PAGE ▸** twice, and then press **Knob 1 (Add to Favorites)**. The Favorites list appears.

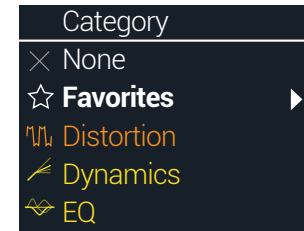

3. To replace an existing favorite, turn the Lower Knob to select the Favorite you want to replace, and press **Knob 2 (Replace Favorite)***.

To add a new favorite, turn the Lower Knob to select the location where you want to add it, and press **Knob 3 (Add New Favorite)**.

Once added and you return to the Home - Edit screen, the model and its stored settings appear within the Inspector, now with the favorites icon at its left, replacing its previous category icon.

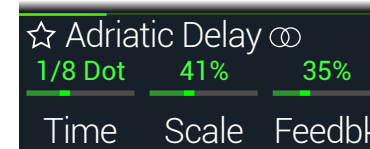

4. **OPTIONAL:** From the Home - Edit screen, press the lower knob, choose the Favorites category within the Model list, select one of your Favorites, and press **ACTION** to manage them.

- To clear the selected favorite, press **Clear Favorite**
- To reorder the selected favorite up or down the list, turn **Reorder Favorite**
- To rename the selected favorite, press **Rename Favorite**

To put your favorites to use... Within any preset, select an empty block and turn the Lower Knob clockwise. Each of your perfectly-tweaked favorite amps and effects instantly appears, without having to open the model list at all!

***NOTE:** If you replace and overwrite an existing favorite that is already in use within your presets, the presets remain unchanged. However, if you want to "update" any preset to use the newly-edited favorite, select the existing favorite block with the preset, and turn the Lower Knob one click away and then back to effectively "reload" the updated favorite.

TIP: Using the HX Edit app, you can export your favorites to your computer as .fav files, allowing you to build a virtually limitless collection that can be imported back into your device's Favorites library at any time—as well as shared between devices, or with other Helix/HX device and Helix Native owners! HX Edit also offers several features for efficiently managing your Favorites library.

Saving a Model's Default Settings

If you find yourself constantly re-tweaking your commonly-used models the same way, you can save a model's settings as its new defaults (excluding Input, Output, Split, or Merge Mixer blocks' settings) so the model shows up that way every time.

1. Choose any model and tweak it exactly how you like it.

Configure any of its parameters and bypass state. (Existing MIDI, bypass, snapshot, and controller assignments are *not* saved with the User Model Defaults.)

2. Press ACTION, press PAGE ▸ twice, and then Knob 3 (User Default).



All your current parameter settings are now saved as the default for all future uses of the model. (Existing presets that include the model are not affected.)

 **NOTE:** To return a model to factory defaults, press ACTION, press PAGE ▸ twice, and then press Knob 2 (Factory Default). No current presets' model settings are changed—you'll see the factory defaults restored the next time you insert the model.

Saving/Naming a Preset

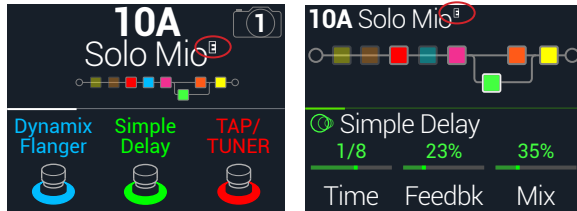
Whenever a preset has been edited from its last-saved state, a small "E" indicator appears to the preset title's right, in both the Play and Edit view screens. Be sure to use the following steps to Save your preset if you want to retain all current edits.



 **SHORTCUT:** To quickly save any changes to the current preset, press  and ACTION together twice. Remember the mantra—save early and save often!

1. Press and ACTION together to open the Save Preset screen:

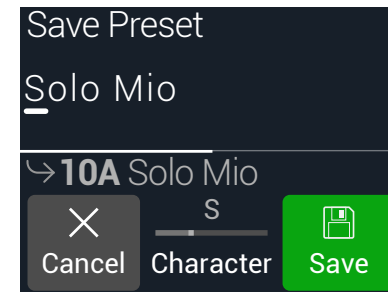

Turn the Upper Knob to move the cursor left and right.

Turn Knob 2 (Character) to change the selected character.

Press PAGE ▸ and then Knob 1 (Delete) to delete the selected character and shift all following characters to the left.

Press PAGE ▸ and then Knob 2 (Insert) to insert a space and shift all following characters to the right.

 **SHORTCUT:** Press Knob 2 (Character) to cycle between upper case, lower case, 0, and [SPACE].

2. Turn the Lower Knob to choose the preset location you wish to overwrite.

Any of the 126 presets can be overwritten.

3. Press Knob 3 (Save).

Creating/Restoring Full Device Backups

Creating full backups of your HX Stomp device's presets, IRs, Favorites, custom model defaults, and global settings is highly recommended to make sure your precious custom tones and configurations are never lost! Fortunately, the free Line 6 **HX Edit** app makes it easy to create full backups and restore them anytime (available from line6.com/software). Please refer to the [HX Edit Pilot's Guide](#) for steps on how to use its built-in Backup & Restore features.

Serial vs. Parallel Routing

For many guitar tones, a serial (a single, stereo path) signal flow is more than adequate. For example, the preset below includes a Pitch/Synth block (violet) > Amp block (red) > IR block (pink) > Modulation block (blue) > Delay block (green) > and Reverb block (dark orange):

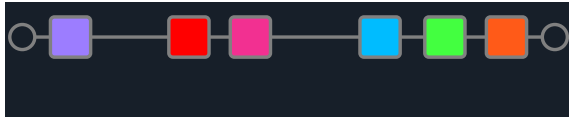

For more sophisticated tones, a parallel (two stereo paths) signal flow can be created. This lets one split the signal into two stereo paths, process them separately, and mix the two paths back together.

A few advantages of parallel routing:

- If a reverb follows a delay on a serial path, the delay's echoes will have reverb applied. Likewise, if a delay follows a reverb on a serial path, the reverb's tail will have distinct echoes. Conversely, if a reverb and delay are on separate parallel paths, they won't affect one another and can sometimes result in cleaner, more defined notes
- If your effect blocks don't have Mix or Blend controls, adding them to a parallel path allows the dry guitar or bass signal to pass through unaffected and be blended with the effected signal. This can be especially effective when blending clean and distorted bass signals
- Instead of a single Amp+Cab block, you may be able to run a standalone Amp block into two parallel Cab blocks or Impulse Responses (or one of each)
- With stereo rigs, each path can be panned freely between the left and right speakers or amps by using the Mixer block. Different delay and/or reverb models panned hard left and hard right can sound particularly huge

TIP. Remember that with parallel routing, both paths A and B are stereo paths, allowing you to utilize either mono or stereo processing blocks on each, and pan as desired. See ["Block Order and Stereo Imaging" on page 21](#).

1. From Edit view, turn the Upper Knob to select a processing block and press ACTION to pick it up.
2. Turn Knob 1 (Path) to select "B."

The Delay block is moved to a newly created parallel path B.

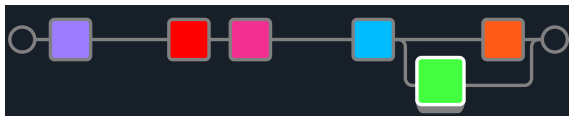

In the preceding illustration:

Our guitar signal goes into the Pitch, Amp, IR, and Modulation blocks, and then is split to path A (upper) and path B (lower).

Stereo path A (upper) is sent to the dark orange Reverb block and stereo path B (lower) is sent to the green Delay block.

Stereo paths A and B are merged together and sent to the Output.

3. Press ACTION again to drop the Delay block.

To remove path B, return all blocks that reside on path B (lower) to path A (upper).

Setting Path B's Output

There may be situations where you want parallel path B to be sent to a completely different set of outputs.

1. From Edit view, turn the Upper Knob to select the point where the two paths merge.

The Mixer block appears only when selected:



2. Press ACTION and turn Knob 1 (Path) to select "B."

The Mixer moves to path B, and a new Output block is created. In this case, path A is being sent from the HX Stomp Main L/R outputs, and path B is being sent from its stereo Send L/R output:



3. Press ACTION again to drop the Mixer block.

TAP Tempo

From either Stomp or Scroll footswitch modes, press FS3 (TAP/TUNER) repeatedly to set the tempo in BPM (Beats Per Minute).

Certain Delay and Modulation parameters such as Time and Speed can be represented with fixed numeric values (ms or Hz) or note values (1/4-note, dotted 1/8-note, etc.). When set to note values, the parameter will follow Tap Tempo or incoming MIDI clock. Press the parameter knob to toggle between ms (or Hz) and note values.

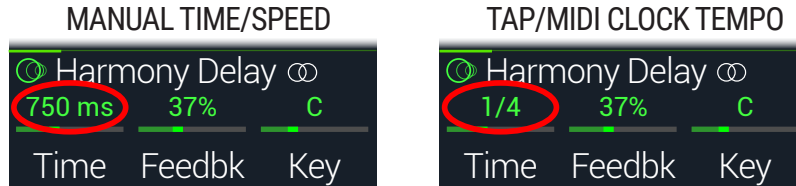

NOTE: The HX Stomp device does not respond to pressing TAP at tempi lower than 40.0 BPM to ensure that multiple fast tap entries are recognized properly. You may still manually select a tempo as low as 20.0 BPM using the Global Settings or Knob 3 BPM parameter options described below.

The current tempo can also be set from ["Global Settings > MIDI/Tempo"](#).

SHORTCUT: From Stomp or Scroll mode, touch FS3 (TAP/TUNER) to briefly display Tempo parameters.



Knob	Parameter	Description
2	Tempo	Choose whether the tempo is stored and recalled with each snapshot, recalled with each preset, or is applied globally across all presets and snapshots.
3	BPM	Depending on the Knob 2 (Tempo) setting, this Beats Per Minute value is saved per snapshot, per preset, or globally.

The Tuner

HX Stomp offers three Tuner types, Fine (shown below), Coarse, and Strobe, selectable from Knob 3 of the Tuner Settings—see the following ["Tuner Settings"](#) table.

1. If not already there, press VIEW to select Play view.
2. Press PAGE or PAGE to select either Stomp Mode or Scroll Mode. FS3 appears as TAP/TUNER.
3. Hold FS3 (TAP/TUNER) until the Tuner screen appears:

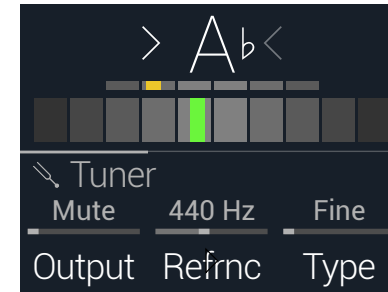

4. Pluck an individual string on your guitar.

When the colored box is left of center, your string is flat. When the colored box is right of center, your string is sharp. When the colored box approaches the correct tuning, a second smaller colored box can be used for greater precision. When both arrows are illuminated, your string is perfectly in tune.

5. To exit the Tuner, step on any footswitch.

All tuner settings are global.

TIP: If you have a favorite pedal tuner and wish to use it instead of the tuner in HX Stomp, connect the HX Stomp Send output to your tuner's input and turn Knob 1 (Output) to select "Send L/R." This way, every time you hold the TAP footswitch, HX Stomp will automatically route the signal to your favorite tuner.

SHORTCUT: You can also use ACTION + PAGE to access the Tuner.

Tuner Settings

Page	Knob	Parameter	Description
1	1	Output	Determines the active output while the Tuner screen is active. If you prefer to hear nothing while tuning, choose "Mute." Normally, you should choose "Main L/R."
	2	Refrnc	If you'd like to tune to a reference other than standard 440 Hz, select from 425 to 455 Hz.
	3	Type	Choose between three Tuner types: Fine (color-changing, needle tuner with fine-tuning bar, the default type), Coarse (color-changing needle tuner with no fine-tuning bar), or Strobe. The Tuner accurately tunes notes down to 21.83 Hz (low F) for 5-string basses.
2	1	Offsets	Enables the Tuner offsets displayed on Pages 2~4.
	2	String 6 Offset	Some guitarists feel that tuning certain strings slightly sharp or flat in relation to concert tuning can improve intonation. String offsets calibrate the tuner so that these slightly out-of-tune pitches appear as in tune. String 6 is low E, and String 1 is high E. Tuning offsets won't be applied unless Knob 3 (Offsets) on Page 1 is turned on.
	3	String 5 Offset	
1	String 4 Offset		
3	2	String 3 Offset	
	3	String 2 Offset	
4	1	String 1 Offset	

Dynamic DSP

Like nearly all modern audio processors, the HX Stomp engine is based on DSP (Digital Signal Processing). Some models require many times more DSP horsepower than others, so it makes logical sense that fewer of those models could exist in a tone. To work around this, some processors restrict you to one amp, one reverb, one delay, etc. With HX Stomp, who are we to say you can't run eight distortions in a row? Or two Amp blocks into two IRs? Or two parallel mods into two parallel delays into two parallel reverbs for some massive swirly stereo ambient wash? We feel it's important to let you keep adding whatever you want to your tone, even if you may eventually run out of DSP.

To see which models can be added to the current preset, from Edit view, press the Lower Knob to open the model list.

Grayed-out items cannot be accommodated and are skipped over - See ["Selecting Blocks/Adjusting Parameters"](#).

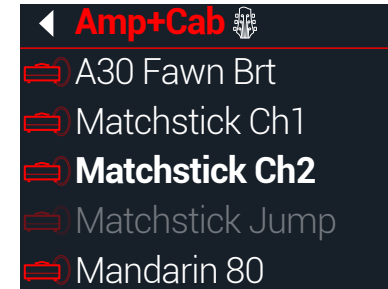

Tips to Optimize DSP

- Some block types use much more DSP than others, such as Amps, IRs, Reverbs, and models that utilize polyphonic pitch shifting (Delay - Poly Sustain, Modulation - Poly Detune, and Pitch - Poly Pitch, Poly Wham, Poly Capo, 12-String)
- Instead of a parallel path with two Amp+Cab blocks or two separate Amps and Cabs, try adding a single Amp block followed by a single Cab > Dual block (mixing two different Cabs can provide some substantial variations)
- The stereo version of an effects block will use roughly twice as much DSP as a mono version of the same block. Likewise, the dual version of a cab block will use roughly twice as much DSP as the single version
- Some model categories have "Simple" blocks, which utilize less DSP than others
- Effects models in the Legacy subcategory generally—but not always—use less DSP than those in the Mono and Stereo subcategories
- Instead of toggling between two of the same amp or effects blocks (with different settings), use controllers or snapshots to instantly adjust parameters within a single block. You'd be surprised at how wildly different tones you can get from simply adjusting an amp model's tonestack knobs

Block Order and Stereo Imaging

The signal path in HX Stomp is stereo, carrying two channels of audio. When the device is fed a stereo input source (i.e., when discrete left and right signals are connected into the HX Stomp Left and Right input jacks), the source audio is processed discretely in stereo wherever stereo blocks are used within the path. Whenever a mono block is added within a path, both channels of audio are combined and sent out of the block as mono.

Most of the effects models in HX Stomp have both mono and stereo versions. A stereo block displays  after its model name in the inspector. The stereo imaging—or how wide your tone appears with stereo speakers or headphones—is highly dependent on the type of blocks you add and in what order.

Legacy effects models vary in behavior, just as on the classic Line 6 effects from where these models originated.

- Legacy Distortion, Dynamics & Pitch/Synth effects are mono
- Legacy Modulation & Delay effects vary in that some are mono, some stereo, and some mono in/stereo out, where adjusting the effect's Mix parameter can narrow the stereo image fed into them. It's best to experiment with these effects and tweak the Mix parameter to achieve the desired stereo output results
- Legacy Filter and Reverb effects are stereo



TIP. Even if you're running a single amp or other mono playback system, sometimes stereo effects can still sound “fuller” than their mono counterparts. This is especially true with stereo reverbs.

The Blocks

Input

The Input block has a dedicated noise gate. Threshold and Decay parameters are grayed out unless Knob 1 (Gate) is turned on.

The vast majority of the time, you'll want the Input block to be fed from the Main L/MONO and RIGHT inputs. However, you can instead feed the Return L/MONO and RIGHT inputs into the signal flow or even USB In 5/6 for re-amping purposes.

From Edit view, turn the Upper Knob to select the Input block and then turn the Lower Knob to change the input.

INPUT MAIN L/R

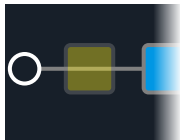

INPUT RETURN L/R

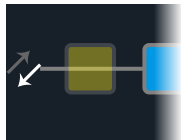

INPUT USB 5/6

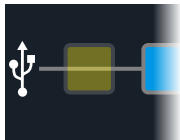

Main L/R Both the L/MONO and RIGHT inputs are active simultaneously. Normally, you should choose Input Main L/R.

Return L/R Return L/MONO and RIGHT can act as a stereo Input block for processing keyboards, a drum machine, or even another modeler. If a Return or FX Loop processing block exists in the preset, the utilized Return input will be non-selectable. See [“Send/Return”](#).

USB 5/6 USB inputs 5/6 can be used for processing tracks from your Mac or Windows DAW software. See [“USB Audio”](#).

NOTE: HX Stomp also receives input from USB 1/2 and 3/4, but they're dedicated to monitoring audio from your computer (or iPad device) and bypass all processing blocks. As such, USB 1/2 or 3/4 are not available as input block sources.

TIP: The Input block includes a built-in signal present/clip indicator—see [page 23](#).

Input Settings

Page	Knob	Parameter	Description
	1	Gate	Turns the Input noise gate on and off.
1	2	Thresh[old]	Sets the input level at which the noise gate acts on the signal. If your guitar gets cut off abruptly, turn the Threshold up.
	3	Decay	Determines how abruptly the noise gate is applied once the signal drops below the threshold level.
2	1	In-Z	HX Stomp has an impedance circuit on its Main L/R inputs that affects tone and feel by loading your guitar's pickups as they would by an effect pedal or amplifier. A lower value will typically result in some high frequency attenuation, lower gain, and an overall “softer” feel. A higher value provides full frequency response, higher gain, and an overall “tighter” feel. The “Auto” option allows the impedance to reflect the impedance of the first block in the signal path—also see the Auto Impedance option in “Global Settings > Preferences”

Outputs

Most presets have one Output Main L/R block, used to adjust its overall level and balance between stereo speakers. When a parallel path configuration exists, if you route the Mixer block to path B, a second Output block appears for routing path B signals from the stereo Send output. See [“Setting Path B's Output”](#).

OUTPUT MAIN L/R

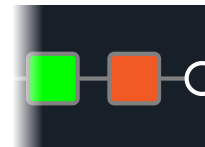

OUTPUT MAIN L/R+SEND L/R



Output Settings

Knob	Parameter	Description
1	Pan	Sets the balance between the left and right outputs. If you're only running the L/MONO output, leave this set to Center.
2	Level	Sets the overall level of the entire preset.
3	Type (Send only)	Determines whether the Send L/R Output (appears when the Mixer block is routed to Path B) is mono or stereo.

TIP: Output blocks include a built-in signal present/clip indicator—see next section.

Signal Present and Clip Indicators

For path Input and Output blocks - These blocks display with a green fill to indicate a signal is present and a red fill if the signal is too hot. If clipping is indicated, reduce the signal level before and/or at the red indicated Input/Output block, as shown below.

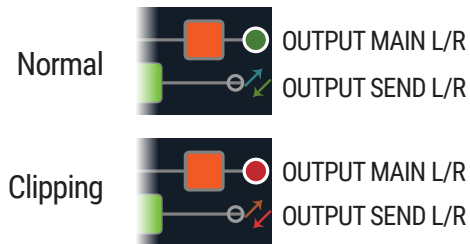
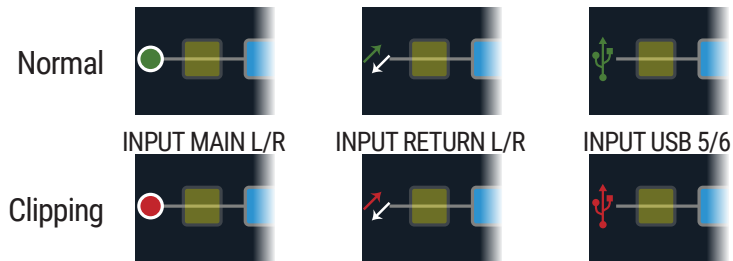

For Send/Return - Send, Return, and FX Loop blocks - Whenever the signal level at any of these block types is too hot, a red fill color is displayed as a clip indicator. If clipping is indicated, you should reduce the signal level preceding the red indicated block and/or at the red indicated Send/Return block.



Effects

HX Stomp has all the effects of the Line 6 award-winning Helix guitar processor. These effects are found within the Mono and Stereo subcategories of the model list. In addition, HX Stomp includes selected effects from the classic Line 6 DL4™, DM4™, MM4™, and FM4™ stompboxes, as well as M13®, M9®, and M5® processors; these appear in the Legacy subcategory.



From Edit view, turn the Upper Knob to select the desired block and then turn the Lower Knob to change its model, or press the Lower Knob to enter the Model menu.

TIP: The Favorites category that appears at the start of the Model menu is initially empty, awaiting you to add your preferred models to it—see [page 16](#).

Distortion Models

Model	Subcategories	Based On*
Kinky Boost	Mono, Stereo	Xotic® EP Booster
Deranged Master	Mono, Stereo	Dallas Rangemaster Treble Booster
Minotaur	Mono, Stereo	Klon® Centaur
Teemah!	Mono, Stereo	Paul Cochrane Timmy® Overdrive
Heir Apparent	Mono, Stereo	Analogman Prince of Tone
Tone Sovereign	Mono, Stereo	Analogman King of Tone
Alpaca Rogue	Mono, Stereo	Way Huge® Red Llama (modded)
Compulsive Drive	Mono, Stereo	Fulltone® OCD
Dhyana Drive	Mono, Stereo	Hermida Zendrive
Horizon Drive	Mono, Stereo	Horizon Precision Drive
Valve Driver	Mono, Stereo	Chandler Tube Driver
Top Secret OD	Mono, Stereo	DOD® OD-250
Scream 808	Mono, Stereo	Ibanez® TS808 Tube Screamer®
Hedgehog D9	Mono, Stereo	MAXON® SD9 Sonic Distortion
Stupor OD	Mono, Stereo	BOSS® SD-1 Overdrive
Deez One Vintage	Mono, Stereo	BOSS DS-1 Distortion (Made-in-Japan)
Deez One Mod	Mono, Stereo	BOSS DS-1 Distortion (Keeley modded)

*See "U.S. Registered Trademarks" on page 37. All product names used in this document are trademarks of their respective owners and neither Yamaha Guitar Group nor Line 6 are associated or affiliated with them. These trademarks appear solely to identify products whose tones and sounds were studied by Line 6 during sound model development.

Distortion Models

Model	Subcategories	Based On*
Vermin Dist	Mono, Stereo	Pro Co RAT
KWB	Mono, Stereo	Benadrian Kowloon Walled Bunny Distortion
Legendary Drive	Mono, Stereo	Carvin® VLD1 Legacy Drive (hi gain channel)
Swedish Chainsaw	Mono, Stereo	BOSS HM-2 Heavy Metal Distortion (MIJ)
Arbitrator Fuzz	Mono, Stereo	Arbiter® Fuzz Face®
Pocket Fuzz	Mono, Stereo	Jordan Boss Tone Fuzz
Bighorn Fuzz	Mono, Stereo	'73 Electro-Harmonix® Ram's Head Big Muff Pi
Triangle Fuzz	Mono, Stereo	Electro-Harmonix Big Muff Pi
Ballistic Fuzz	Mono, Stereo	Euthymia ICBM Fuzz
Industrial Fuzz	Mono, Stereo	Z.Vex Fuzz Factory
Tycoctavia Fuzz	Mono, Stereo	Tycobrahe® Octavia
Wringer Fuzz	Mono, Stereo	Garbage's modded BOSS FZ-2
Thrifter Fuzz	Mono, Stereo	Line 6 Original
Xenomorph Fuzz	Mono, Stereo	Subdecay Harmonic Antagonizer
Megaphone	Mono, Stereo	Megaphone
Bitcrusher	Mono, Stereo	Line 6 Original
Ampeg Scrambler	Mono, Stereo	Ampeg® Scrambler Bass Overdrive
ZeroAmp Bass DI	Mono, Stereo	Tech 21® SansAmp Bass Driver DI V1
Obsidian 7000	Mono, Stereo	Darkglass® Electronics Microtubes® B7K Ultra
Clawthorn Drive	Mono, Stereo	Wounded Paw Battering Ram
Tube Drive	Legacy	Chandler Tube Driver
Screamer	Legacy	Ibanez Tube Screamer
Overdrive	Legacy	DOD Overdrive/Preamp 250
Classic Dist	Legacy	ProCo RAT
Heavy Dist	Legacy	BOSS Metal Zone
Colordrive	Legacy	Colorsound® Overdriver
Buzz Saw	Legacy	Maestro® Fuzz Tone
Facial Fuzz	Legacy	Arbiter Fuzz Face
Jumbo Fuzz	Legacy	Vox® Tone Bender

Distortion Models

Model	Subcategories	Based On*
Fuzz Pi	Legacy	Electro-Harmonix Big Muff Pi
Jet Fuzz	Legacy	Roland® Jet Phaser
L6 Drive	Legacy	Colorsound Overdriver (modded)
L6 Distortion	Legacy	Line 6 Original
Sub Oct Fuzz	Legacy	PAiA Roctave Divider
Octave Fuzz	Legacy	Tycobrahe Octavia

Dynamics Models

Model	Subcategories	Based On*
Deluxe Comp	Mono, Stereo	Line 6 Original
Red Squeeze	Mono, Stereo	MXR® Dyna Comp
Kinky Comp	Mono, Stereo	Xotic SP Compressor
Rochester Comp	Mono, Stereo	Ashly® CLX-52 (in conjunction w/ B. Sheehan)
LA Studio Comp	Mono, Stereo	Teletronix® LA-2A®
3-Band Comp	Mono, Stereo	Line 6 Original
Noise Gate	Mono, Stereo	Line 6 Original
Hard Gate	Mono, Stereo	Line 6 Original
Horizon Gate	Mono, Stereo	Horizon Precision Drive - Gate Circuit
Autoswell	Mono, Stereo	Line 6 Original
Tube Comp	Legacy	Teletronix LA-2A
Red Comp	Legacy	MXR Dyna Comp
Blue Comp	Legacy	BOSS CS-1
Blue Comp Treb	Legacy	BOSS CS-1 (Treble switch on)
Vetta Comp	Legacy	Line 6 Original
Vetta Juice	Legacy	Line 6 Original
Boost Comp	Legacy	MXR Micro Amp

*See "U.S. Registered Trademarks" on page 37. All product names used in this document are trademarks of their respective owners and neither Yamaha Guitar Group nor Line 6 are associated or affiliated with them. These trademarks appear solely to identify products whose tones and sounds were studied by Line 6 during sound model development.

EQ Models

Model	Subcategories	Based On*
Simple EQ	Mono, Stereo	Line 6 Original
Low and High Cut	Mono, Stereo	Line 6 Original
Low/High Shelf	Mono, Stereo	Line 6 Original
Parametric	Mono, Stereo	Line 6 Original
Tilt	Mono, Stereo	Line 6 Original
10 Band Graphic	Mono, Stereo	MXR 10-Band Graphic EQ
Cali Q Graphic	Mono, Stereo	MESA/Boogie® Mark IV Graphic EQ
Acoustic Sim	Mono, Stereo	Line 6 Original

Modulation Models

Model	Subcategories	Based On*
Optical Trem	Mono, Stereo	Fender® optical tremolo circuit
60s Bias Trem	Mono, Stereo	Vox AC-15 Tremolo
Tremolo/Autopan	Mono, Stereo	BOSS PN-2
Harmonic Tremolo	Mono, Stereo	Line 6 Original
Bleat Chop Trem	Mono, Stereo	Lightfoot Labs Goatkeeper
Script Mod Phase	Mono, Stereo	MXR Phase 90
Pebble Phaser	Mono, Stereo	Electro-Harmonix Small Stone
Ubiquitous Vibe	Mono, Stereo	Shin-ei Uni-Vibe®
Deluxe Phaser	Mono, Stereo	Line 6 Original
Gray Flanger	Mono, Stereo	MXR 117 Flanger
Harmonic Flanger	Mono, Stereo	A/DA Flanger
Courtesan Flange	Mono, Stereo	Electro-Harmonix Deluxe EM
Dynamix Flanger	Mono, Stereo	MicMix DynaFlanger
Chorus	Mono, Stereo	Line 6 Original
70s Chorus	Mono, Stereo	BOSS CE-1
PlastiChorus	Mono, Stereo	Modded Arion SCH-Z chorus
Trinity Chorus	Stereo	Dytronics® Tri-Stereo Chorus
Bubble Vibrato	Mono, Stereo	BOSS VB-2 Vibrato
Vibe Rotary	Stereo	Fender Vibratone

Modulation Models

Model	Subcategories	Based On*
122 Rotary	Stereo	Leslie® 122
145 Rotary	Stereo	Leslie 145
Double Take	Mono, Stereo	Line 6 Original
Poly Detune †	Mono	Line 6 Original
AM Ring Mod	Mono, Stereo	Line 6 Original
Pitch Ring Mod	Stereo	Line 6 Original
Pattern Tremolo	Legacy	Line 6 Original
Panner	Legacy	Line 6 Original
Bias Tremolo	Legacy	1960 Vox AC-15 Tremolo
Opto Tremolo	Legacy	1964 Fender Deluxe Reverb®
Script Phase	Legacy	MXR Phase 90 (script logo version)
Panned Phaser	Legacy	Ibanez Flying Pan
Barberpole	Legacy	Line 6 Original
Dual Phaser	Legacy	Mu-Tron® Bi-Phase
U-Vibe	Legacy	Shin-ei Uni-Vibe
Phaser	Legacy	MXR Phase 90
Pitch Vibrato	Legacy	BOSS VB-2
Dimension	Legacy	Roland Dimension D
Analog Chorus	Legacy	BOSS CE-1
Tri Chorus	Legacy	Dytronics Tri-Stereo Chorus
Analog Flanger	Legacy	MXR Flanger
Jet Flanger	Legacy	A/DA Flanger
AC Flanger	Legacy	MXR Flanger
80A Flanger	Legacy	A/DA Flanger
Frequency Shift	Legacy	Line 6 Original
Ring Modulator	Legacy	Line 6 Original
Rotary Drum	Legacy	Fender Vibratone
Rotary Drum/Horn	Legacy	Leslie 145

*See "U.S. Registered Trademarks" on page 37. All product names used in this document are trademarks of their respective owners and neither Yamaha Guitar Group nor Line 6 are associated or affiliated with them. These trademarks appear solely to identify products whose tones and sounds were studied by Line 6 during sound model development.

† The Poly Detune model utilizes polyphonic pitch shifting and, therefore, is extremely DSP-intensive—possibly utilizing up to half of a preset's available DSP!

Delay Models

Model	Subcategories	Based On*
Simple Delay	Mono, Stereo	Line 6 Original
Mod/Chorus Echo	Mono, Stereo	Line 6 Original
Dual Delay	Stereo	Line 6 Original
Multitap 4	Stereo	Line 6 Original
Multitap 6	Stereo	Line 6 Original
Ping Pong	Stereo	Line 6 Original
Sweep Echo	Mono, Stereo	Line 6 Original
Ducked Delay	Mono, Stereo	TC Electronic® 2290
Reverse Delay	Mono, Stereo	Line 6 Original
Vintage Digital	Mono, Stereo	Line 6 Original
Vintage Swell	Mono, Stereo	Line 6 Original
Pitch Echo	Mono, Stereo	Line 6 Original
Transistor Tape	Mono, Stereo	Maestro Echoplex® EP-3
Cosmos Echo	Mono, Stereo	Roland RE-201 Space Echo®
Harmony Delay	Stereo	Line 6 Original
Bucket Brigade	Mono, Stereo	BOSS DM-2
Adriatic Delay	Mono, Stereo	BOSS DM-2 w/ Adrian Mod
Adriatic Swell	Mono, Stereo	Line 6 Original
Elephant Man	Mono, Stereo	Electro-Harmonix Deluxe Memory Man
Multi Pass	Mono, Stereo	Line 6 Original
Poly Sustain †	Mono	Line 6 Original
Glitch Delay	Mono, Stereo	Line 6 Original
Ping Pong	Legacy	Line 6 Original
Dynamic	Legacy	TC Electronic 2290
Stereo	Legacy	Line 6 Original
Digital	Legacy	Line 6 Original
Dig w/Mod	Legacy	Line 6 Original
Reverse	Legacy	Line 6 Original
Lo Res	Legacy	Line 6 Original

Delay Models

Model	Subcategories	Based On*
Tube Echo	Legacy	Maestro Echoplex EP-1
Tape Echo	Legacy	Maestro Echoplex EP-3
Sweep Echo	Legacy	Line 6 Original
Echo Platter	Legacy	Binson® EchoRec®
Analog Echo	Legacy	BOSS DM-2
Analog w/Mod	Legacy	Electro-Harmonix Deluxe Memory Man
Auto-Volume Echo	Legacy	Line 6 Original
Multi-Head	Legacy	Roland RE-101 Space Echo

Reverb Models

Model	Subcategory	Based On*
Glitz	Mono, Stereo	Line 6 Original
Ganymede	Mono, Stereo	Line 6 Original
Searchlights	Mono, Stereo	Line 6 Original
Plateaux	Mono, Stereo	Line 6 Original
Double Tank	Mono, Stereo	Line 6 Original
Plate	Legacy	Line 6 Original
Room	Legacy	Line 6 Original
Chamber	Legacy	Line 6 Original
Hall	Legacy	Line 6 Original
Echo	Legacy	Line 6 Original
Tile	Legacy	Line 6 Original
Cave	Legacy	Line 6 Original
Ducking	Legacy	Line 6 Original
Octo	Legacy	Line 6 Original
'63 Spring	Legacy	Line 6 Original
Spring	Legacy	Line 6 Original
Particle Verb	Legacy	Line 6 Original

*See "U.S. Registered Trademarks" on page 37. All product names used in this document are trademarks of their respective owners and neither Yamaha Guitar Group nor Line 6 are associated or affiliated with them. These trademarks appear solely to identify products whose tones and sounds were studied by Line 6 during sound model development.

† The Poly Sustain model utilizes polyphonic pitch shifting and, therefore, is extremely DSP-intensive—possibly utilizing up to half of a preset's available DSP!

Pitch/Synth Models

Model	Subcategories	Based On*
Pitch Wham	Mono, Stereo	Digitech Whammy®
Twin Harmony	Mono, Stereo	Eventide® H3000
Simple Pitch	Mono, Stereo	Line 6 Original
Dual Pitch	Mono, Stereo	Line 6 Original
3 OSC Synth	Stereo	Line 6 Original
Poly Pitch †	Mono	Line 6 Original
Poly Wham †	Mono	Line 6 Original
Poly Capo†	Mono	Line 6 Original
12 String †	Mono	Line 6 Original
3 Note Generator ‡	Mono, Stereo	Line 6 Original
4 OSC Generator ‡	Mono, Stereo	Line 6 Original
Bass Octaver	Legacy	EBS® OctaBass
Smart Harmony	Legacy	Eventide H3000
Octi Synth	Legacy	Line 6 Original
Synth O Matic	Legacy	Line 6 Original
Attack Synth	Legacy	Korg® X911 Guitar Synth
Synth String	Legacy	Roland GR700 Guitar Synth
Growler	Legacy	Line 6 Original

Filter Models

Model	Subcategories	Based On*
Mutant Filter	Mono, Stereo	Musitronics® Mu-Tron III
Mystery Filter	Mono, Stereo	Korg A3
Autofilter	Mono, Stereo	Line 6 Original
Asheville Pattn	Mono, Stereo	Moog® Moogerfooger® MF-105M MuRF Filter

Filter Models

Model	Subcategories	Based On*
Voice Box	Legacy	Line 6 Original
V Tron	Legacy	Musitronics Mu-Tron III
Q Filter	Legacy	Line 6 Original
Seeker	Legacy	Z Vex Seek Wah
Obi Wah	Legacy	Oberheim® voltage-controlled S&H filter
Tron Up	Legacy	Musitronics Mu-Tron III (up position)
Tron Down	Legacy	Musitronics Mu-Tron III (down position)
Throbber	Legacy	Electrix® Filter Factory
Slow Filter	Legacy	Line 6 Original
Spin Cycle	Legacy	Craig Anderton's Wah/Anti-Wah
Comet Trails	Legacy	Line 6 Original

Wah Models

Model	Subcategories	Based On*
UK Wah 846	Mono, Stereo	Vox V846
Teardrop 310	Mono, Stereo	Dunlop® Cry Baby® Fasel model 310
Fassel	Mono, Stereo	Dunlop Cry Baby Super
Weeper	Mono, Stereo	Arbiter Cry Baby
Chrome	Mono, Stereo	Vox V847
Chrome Custom	Mono, Stereo	Modded Vox V847
Throaty	Mono, Stereo	RMC® Real McCoy 1
Vetta Wah	Mono, Stereo	Line 6 Original
Colorful	Mono, Stereo	Colorsound Wah-fuzz
Conductor	Mono, Stereo	Maestro Boomerang

*See "U.S. Registered Trademarks" on page 37. All product names used in this document are trademarks of their respective owners and neither Yamaha Guitar Group nor Line 6 are associated or affiliated with them. These trademarks appear solely to identify products whose tones and sounds were studied by Line 6 during sound model development.

† These indicated Pitch/Synth models utilize polyphonic pitch shifting and, therefore, are extremely DSP-intensive—possibly utilizing up to half of a preset's available DSP!

‡ The 3 Note Generator and 4 OSC Generator models make sound without any instrument connected, therefore, their blocks are turned off by default. Be sure to first set your Helix volume to low, and press BYPASS to turn them on.

Volume/Pan Models

Model	Subcategories	Based On*
Volume Pedal	Mono, Stereo	Line 6 Original
Gain	Mono, Stereo	Line 6 Original
Pan	Stereo	Line 6 Original
Stereo Width	Stereo	Line 6 Original
Stereo Imager	Stereo	Line 6 Original

Common FX Settings

Parameter	Description
Drive	Adjusts the amount of overdrive, distortion, or fuzz.
Bass	Adjusts the bass level.
Mid	Adjusts the midrange level.
Treble	Adjusts the treble level.
Speed	Adjusts the speed of the effect, with higher settings providing faster rates. Press the knob to toggle between Hz and note values. Choosing a Hz value provides a specific modulation speed in cycles per second; choosing a note value provides a time based on the current tempo. Not all Speed parameters can be synced to note values, as they may be non-linear and highly interactive. (Note that stepping on TAP once resets any LFO-based effects, such as tremolos and rotary speakers.)
Rate	Adjusts the rate of the effect, with higher settings providing faster rates. Press the knob to toggle between numeric and note values. Not all Rate parameters can be synced to note values, as they may be non-linear and highly interactive. (Note that stepping on TAP once resets any LFO-based effects, such as tremolos and rotary speakers.)
Time	Adjusts the delay/repeat time, with higher settings providing longer delays. Press the knob to toggle between ms and note values. Choosing a ms value provides a specific time in milliseconds; choosing a Note Division value provides a time based on the current tempo. With a note division value, this parameter's value is retained when changing models.
Scale	Delay models with multiple taps have a Scale parameter for each tap, which adjusts its time relative to the main Time value. For example, if the Time parameter is set to 500ms, setting the T1 Scale to "50%" will mean that tap will be at 250ms. If you then adjust the Time parameter, the timing of all the taps will scale accordingly.
Depth	Adjusts the intensity of the modulation. Higher settings result in more extreme pitch bending, wobble, or throb, depending on the effect.
Feedbk	Adjusts the amount of delayed signal fed back into the effect. Higher settings can provide more dramatic textures.

Parameter	Description
Decay	Sets the length of time the reverb effect sustains.
Predly	Determines predelay—or the time before the reverb effect is heard.
Spread	Spread differs slightly among stereo delay effects. For most delays, it adjusts how widely the repeats bounce left and right. For example, with the Ping Pong Delay, 0 is in the middle (mono), and 10 is full left to right panning for the repeats. For modulated stereo delays, Spread affects the LFOs' (low frequency oscillators) stereo modulation behavior. At 0, the LFOs are in sync. At 10, the two LFOs are 180 degrees out of sync, so that when one side is modulating up, the other side is modulating down.
Headrm	Some mod and delay pedals' internal signal paths exhibit a bit of grit, especially when placed after a high-gain distortion block. Negative values increase the perceived amount of grit; positive values clean things up a bit. At 0dB, the model behaves like the original pedal.
Low Cut	Filters a portion of the block's bass and/or treble frequencies, which can help remove rumble and/or high-end harshness.
Hi Cut	
Mix	Blends the effected "wet" signal vs. the "dry" signal passed through the block. When set to 0%, the path bypasses the effect completely. When set to 100%, the entire path is fed through the effect, and no dry thru signal is heard.
Level	Adjusts the overall output level of the effects block. Be careful not to boost this parameter too high on multiple blocks, as digital clipping could occur (also see " Signal Present and Clip Indicators "). You should typically leave this at 0.0dB for most blocks. Where the original pedal's level or volume knob behavior doesn't really apply to dB values, 0.0-10 may be used.
Trails	<i>Trails Off:</i> Any delay repeats or reverb decays are instantly muted when the block is bypassed. <i>Trails On:</i> Any delay repeats or reverb decays continue to decay naturally when the block is bypassed, or a different snapshot is selected.

*See "[U.S. Registered Trademarks](#)" on page 37. All product names used in this document are trademarks of their respective owners and neither Yamaha Guitar Group nor Line 6 are associated or affiliated with them. These trademarks appear solely to identify products whose tones and sounds were studied by Line 6 during sound model development.

Amp+Cab

Amp+Cab blocks are convenient in that when you select an Amp model, its matching Cab model is automatically loaded. It also only uses up one of the eight available processing blocks.



To change the amp model in an Amp+Cab block, press ◀ PAGE until the amp icon is bright red and turn the Lower Knob. To change the cab model, press PAGE ▶ until the cab icon is bright red and turn the Lower Knob.

Amp Models		
Model	Subcategory	Based On*
WhoWatt 100	Guitar	Hiwatt® DR-103 Brill
Soup Pro	Guitar	Supro® S6616
Stone Age 185	Guitar	Gibson® EH-185
Voltage Queen	Guitar	Victoria Vintage Queen
Tweed Blues Nrm	Guitar	Fender Bassman® (normal channel)
Tweed Blues Brt	Guitar	Fender Bassman (bright channel)
Fullerton Nrm	Guitar	Fender 5C3 Tweed Deluxe (normal channel)
Fullerton Brt	Guitar	Fender 5C3 Tweed Deluxe (bright channel)
Fullerton Jump	Guitar	Fender 5C3 Tweed Deluxe (jumped channels)
Grammatico Nrm	Guitar	Grammatico LaGrange (normal channel)
Grammatico Brt	Guitar	Grammatico LaGrange (bright channel)
Grammatico Jump	Guitar	Grammatico LaGrange (jumped channels)
US Small Tweed	Guitar	Fender Champ®
US Princess	Guitar	Fender Princeton Reverb®
US Deluxe Nrm	Guitar	Fender Deluxe Reverb (normal channel)
US Deluxe Vib	Guitar	Fender Deluxe Reverb (vibrato channel)
US Double Nrm	Guitar	Fender Twin Reverb® (normal channel)
US Double Vib	Guitar	Fender Twin Reverb (vibrato channel)
Mail Order Twin	Guitar	Silvertone® 1484
Divided Duo	Guitar	÷13 JRT 9/15

Amp Models		
Model	Subcategory	Based On*
Interstate Zed	Guitar	Dr Z® Route 66
Derailed Ingrid	Guitar	Trainwreck® Circuits Express
Jazz Rivet 120	Guitar	Roland JC-120 Jazz Chorus
Essex A15	Guitar	Vox AC-15
Essex A30	Guitar	Vox AC-30 with top boost
A30 Fawn Nrm	Guitar	Vox AC-30 Fawn (normal channel)
A30 Fawn Brt	Guitar	Vox AC-30 Fawn (bright channel)
Matchstick Ch1	Guitar	Matchless® DC30 (channel 1)
Matchstick Ch2	Guitar	Matchless DC30 (channel 2)
Matchstick Jump	Guitar	Matchless DC30 (jumped)
Mandarin 80	Guitar	Orange® OR80
Brit J45 Nrm	Guitar	Marshall® JTM-45 (normal channel)
Brit J45 Brt	Guitar	Marshall JTM-45 (bright channel)
Brit Trem Nrm	Guitar	Marshall JTM-50 (normal channel)
Brit Trem Brt	Guitar	Marshall JTM-50 (bright channel)
Brit Trem Jump	Guitar	Marshall JTM-50 (jumped)
Brit Plexi Nrm	Guitar	Marshall Super Lead 100 (normal channel)
Brit Plexi Brt	Guitar	Marshall Super Lead 100 (bright channel)
Brit Plexi Jump	Guitar	Marshall Super Lead 100 (jumped)
Brit P75 Nrm	Guitar	Park® 75 (normal channel)
Brit P75 Brt	Guitar	Park 75 (bright channel)
Brit 2204	Guitar	Marshall JCM-800
Placater Clean	Guitar	Friedman BE-100 (clean channel)
Placater Dirty	Guitar	Friedman BE-100 (BE/HBE channel)
Cartographer	Guitar	Ben Adrian Cartographer
German Mahadeva	Guitar	Bogner® Shiva
German Ubersonic	Guitar	Bogner Überschall®
Cali Texas Ch1	Guitar	MESA/Boogie Lone Star (clean channel)
Cali Texas Ch2	Guitar	MESA/Boogie Lone Star (drive channel)
Cali IV Rhythm 1	Guitar	MESA/Boogie Mark IV (channel I)

*See "U.S. Registered Trademarks" on page 37. All product names used in this document are trademarks of their respective owners and neither Yamaha Guitar Group nor Line 6 are associated or affiliated with them. These trademarks appear solely to identify products whose tones and sounds were studied by Line 6 during sound model development.

Amp Models		
Model	Subcategory	Based On*
Cali IV Rhythm 2	Guitar	MESA/Boogie Mark IV (channel II)
Cali IV Lead	Guitar	MESA/Boogie Mark IV (lead channel)
Cali Rectifire	Guitar	MESA/Boogie Dual Rectifier®
Archetype Clean	Guitar	Paul Reed Smith® Archon® (clean channel)
Archetype Lead	Guitar	Paul Reed Smith Archon (lead channel)
ANGL Meteor	Guitar	ENGL® Fireball 100
Solo Lead Clean	Guitar	Soldano SLO-100 (clean channel)
Solo Lead Crunch	Guitar	Soldano SLO-100 (crunch channel)
Solo Lead OD	Guitar	Soldano SLO-100 (overdrive channel)
PV Panama	Guitar	Peavey® 5150®
Revv Gen Purple	Guitar	Revv® Generator 120 (purple/gain ch. 3)
Revv Gen Red	Guitar	Revv Generator 120 (red/high gain ch. 4)
Das Benzin Mega	Guitar	Diezel VH4 (mega channel)
Das Benzin Lead	Guitar	Diezel VH4 (lead channel)
Line 6 Elektrik	Guitar	Line 6 Original
Line 6 Doom	Guitar	Line 6 Original
Line 6 Epic	Guitar	Line 6 Original
Line 6 2204 Mod	Guitar	Line 6 Original
Line 6 Fatality	Guitar	Line 6 Original
Line 6 Litigator	Guitar	Line 6 Original
Line 6 Badonk	Guitar	Line 6 Original
Ampeg B-15NF	Bass	Ampeg B-15NF Portaflex®
Ampeg SVT Nrm	Bass	Ampeg SVT® (normal channel)
Ampeg SVT Brt	Bass	Ampeg SVT (bright channel)
Ampeg SVT-4 PRO	Bass	Ampeg SVT-4 PRO
Woody Blue	Bass	Acoustic® 360
Agua 51	Bass	Aguilar® DB51
Cali Bass	Bass	MESA/Boogie M9 Carbine
Cali 400 Ch1	Bass	MESA/Boogie Bass 400+ (channel 1)
Cali 400 Ch2	Bass	MESA/Boogie Bass 400+ (channel 2)

Amp Models		
Model	Subcategory	Based On*
G Cougar 800	Bass	Gallien-Krueger® GK 800RB
Del Sol 300	Bass	Sunn® Coliseum 300
Busy One Ch1	Bass	Pearce BC-1 preamp (channel 1)
Busy One Ch2	Bass	Pearce BC-1 preamp (channel 2)
Busy One Jump	Bass	Pearce BC-1 preamp (jumped)
Studio Tube Pre	Preamp > Mic	Requisite Y7 mic preamp

Tonestack and deeper amp parameters found on subsequent pages may differ depending on the amp model selected.

Common Amp Settings

Parameter	Description
Master	Adjusts the amount of overall amp output level, as well as power amp distortion. This parameter is highly interactive with all other power amp parameters—the lower the Master is set, the less effect the other controls will have.
Sag	Lower Sag values offer “tighter” responsiveness for faster metal performances; higher values provide more touch dynamics & sustain for blues and classic rock riffs.
Hum	Controls how much heater hum and AC ripple interacts with your tone.
Ripple	At higher settings, things get freaky.
Bias	Changes the bias of the power tubes. Lower values achieve a “colder” Class AB biasing. At maximum, the amp is operating in Class A.
Bias X	Determines how the power amp tubes’ voicing reacts when pushed hard. Set low for a tighter feel. Set high for more tube compression. This parameter is highly reactive with the Drive and Master settings.

*See “U.S. Registered Trademarks” on page 37. All product names used in this document are trademarks of their respective owners and neither Yamaha Guitar Group nor Line 6 are associated or affiliated with them. These trademarks appear solely to identify products whose tones and sounds were studied by Line 6 during sound model development.

Amp

Amp blocks are identical to Amp+Cab blocks, except they contain no matched cab model.

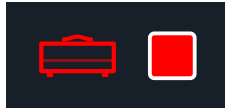

Preamp

We've also included a complete set of Preamp versions of each Amp model, which provide the tone of just the preamp stage of the amp—recommended when feeding the HX Stomp pedal into the power amp section of your favorite amplifier. You'll also find a studio microphone preamp within the Preamp > Mic category.



Preamp blocks require less DSP than a full Amp block.

Cab

There are two subcategories of Cab blocks—Single and Dual. Dual cabs have stereo output, with each cab panned hard left and right. Not surprisingly, dual cabs take twice as much DSP as single cabs.



To change the first cab model in a Cab > Dual block, press <PAGE until the left cab icon is bright red and turn the Lower Knob. To change the second cab, press PAGE> until the right cab icon is bright red and turn the Lower Knob.

Cab Models

Model	Subcategories	Based On*
Soup Pro Ellipse	Single, Dual	1 x 6x9" Supro S6616
1x8 Small Tweed	Single, Dual	1x8" Fender Champ
1x10 US Princess	Single, Dual	1x10" Fender Princeton Reverb
1x12 Field Coil	Single, Dual	1x12" Gibson EH185
1x12 Fullerton	Single, Dual	1x12" Fender 5C3 Tweed Deluxe
1x12 Grammatico	Single, Dual	1x12" Grammatico LaGrange
1x12 US Deluxe	Single, Dual	1x12" Fender Deluxe Oxford
1x12 US Princess	Single, Dual	1x12" Fender Princeton Reverb
1x12 Celest 12H	Single, Dual	1x12" ±13 JRT 9/15 G12 H30
1x12 Blue Bell	Single, Dual	1x12" Vox AC-15 Blue
1x12 Lead 80	Single, Dual	1x12" Bogner Shiva CL80
1x12 Cali IV	Single, Dual	1x12" MESA/Boogie Mk IV
1x12 Cali Ext	Single, Dual	1x12" MESA/Boogie EVM12L
2x12 Double C12N	Single, Dual	2x12" Fender Twin C12N
2x12 Mail C12Q	Single, Dual	2x12" Silvertone 1484
2x12 Interstate	Single, Dual	2x12" Dr Z Z Best V30
2x12 Jazz Rivet	Single, Dual	2x12" Roland JC-120
2x12 Silver Bell	Single, Dual	2x12" Vox AC-30TB Silver
2x12 Blue Bell	Single, Dual	2x12" Vox AC-30 Fawn Blue
2x12 Match H30	Single, Dual	1x12" Matchless DC-30 G12H30
2x12 Match G25	Single, Dual	1x12" Matchless DC-30 Greenback 25
4x10 Tweed P10R	Single, Dual	4x10" Fender Bassman P10R
4x12 WhoWatt 100	Single, Dual	4x12" Hiwatt AP Fane®
4x12 Mandarin EM	Single, Dual	4x12" Orange Eminence®
4x12 Greenback25	Single, Dual	4x12" Marshall Basketweave G12 M25
4x12 Greenback20	Single, Dual	4x12" Marshall Basketweave G12 M20
4x12 Blackback30	Single, Dual	4x12" Park 75 G12 H30
4x12 1960 T75	Single, Dual	4x12" Marshall 1960 AT75
4x12 Uber V30	Single, Dual	4x12" Bogner Uberkab V30
4x12 Uber T75	Single, Dual	4x12" Bogner Uberkab T75

*See "U.S. Registered Trademarks" on page 37. All product names used in this document are trademarks of their respective owners and neither Yamaha Guitar Group nor Line 6 are associated or affiliated with them. These trademarks appear solely to identify products whose tones and sounds were studied by Line 6 during sound model development.

Cab Models

Model	Subcategories	Based On*
4x12 Cali V30	Single, Dual	4x12" MESA/Boogie 4FB V30
4x12 XXL V30	Single, Dual	4x12" ENGL XXL V30
4x12 SoloLead EM	Single, Dual	4x12" Soldano
1x12 Del Sol	Single, Dual	1x12" Sunn Coliseum
1x15 Ampeg B-15	Single, Dual	1x15" Ampeg B-15
1x18 Del Sol	Single, Dual	1x18" Sunn Coliseum
1x18 Woody Blue	Single, Dual	1x18" Acoustic 360
2x15 Brute	Single, Dual	2x15" MESA/Boogie 2x15 EV
4x10 Ampeg HLF	Single, Dual	4x10" Ampeg SVT 410HLF
6x10 Cali Power	Single, Dual	6x10" MESA/Boogie Power House
8x10 Ampeg SVT E	Single, Dual	8x10" Ampeg SVT

Mic Models

Model	Based On*
57 Dynamic	Shure® SM57
409 Dynamic	Sennheiser® MD 409
421 Dynamic	Sennheiser MD 421-U
30 Dynamic	Heil Sound® PR 30
20 Dynamic	Electro-Voice® RE20
121 Ribbon	Royer® R-121
160 Ribbon	Beyerdynamic® M 160
4038 Ribbon	Coles 4038
414 Cond	AKG® C414 TLII
84 Cond	Neumann® KM84
67 Cond	Neumann U67
87 Cond	Neumann U87
47 Cond	Neumann U47
112 Dynamic	AKG D112
12 Dynamic	AKG D12
7 Dynamic	Shure SM7

*See "U.S. Registered Trademarks" on page 37. All product names used in this document are trademarks of their respective owners and neither Yamaha Guitar Group nor Line 6 are associated or affiliated with them. These trademarks appear solely to identify products whose tones and sounds were studied by Line 6 during sound model development.

Cab Settings

Parameter	Description
Mic	Selects one of the 16 available mic models.
Distanc	Sets the distance (1 inch to 12 inches) between the mic and the speaker grille.
Low Cut	Filters a portion of the cab's bass and/or treble frequencies, which can help remove rumble and/or high-end harshness.
High Cut	Filters a portion of the cab's bass and/or treble frequencies, which can help remove rumble and/or high-end harshness.
Reflec	Sets the amount of "early reflections." Higher values add more reflective room sound to your Amp tone.
Level	Adjusts the overall output level of the Cab.

Impulse Response (IR)

Impulse Responses are mathematical functions representing the sonic measurements of specific audio systems (for HX Stomp, acoustic guitar body resonance, or speaker cabinet and microphone combinations). HX Stomp can load and store up to 128 custom or third-party IRs at a time.



TIP: You can get a free pack of IRs right now, available at line6.com/allure, or check out the ever-growing number of custom Helix presets and IR bundles on [Line 6 Marketplace](https://line6.com/marketplace).

IR Formats

For all Helix/HX family devices, as well as Helix Native plugin, the following IR file types are supported.

- **Helix Impulse Response (.hir)** - This is the proprietary Line 6 IR file format. All IRs purchased through the Line 6 Marketplace are of this file type—see "[Marketplace](#)" on [page 5](#).
- **WAV (.wav)** - Most IR producers and vendors typically offer IRs within the .wav format. It is possible to import a mono or stereo .wav file IR, regardless of its bit depth, length, or sample rate frequency. Upon import, IR .wav files are automatically converted to 48kHz sample rate, 32-bit, mono, and 2,048 sample length for Helix. You can use the HX Edit app's Preferences to set the preferred behavior for importing Stereo WAV IRs (import the left or right channel data of the file, or a mix of both).

Loading IRs into HX Stomp

Loading Impulse Response files into HX Stomp requires connecting to the **HX Edit** application in your Mac or Windows computer. The HX Edit application is available as a free download from line6.com/software.

1. **Connect HX Stomp to your computer via USB and open the HX Edit application.**
2. **Click the IRs tab.**

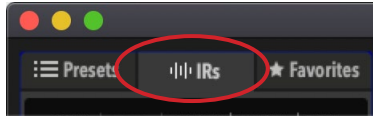

3. **Drag one or more IR files from the desktop or any Finder window directly into the HX Edit application's IRs list (or use the HX Edit IR - Import command).**

The HX Edit app updates the HX Stomp hardware's IR list automatically. HX Stomp can load and store up to 128 IRs at a time.

Loading an IR in an IR Block

Once you've imported IR files into HX Stomp (see the previous section), you can then put them to use by adding one or more IR blocks into your tone. It is recommended to use an Amp block preceding an IR block (rather than an Amp+Cab type block).

1. **Turn the Upper Knob to select an empty block location to the right of your Amp block on the signal path.**
2. **Push the Lower Knob and turn it to select the Impulse Response category.**
3. **Push the Lower Knob to select Mono, and push again to select 1024-sample IR.**

NOTE: You may optionally choose the higher fidelity, 2048-sample IR (there is a max. limit of one 2048-sample IR block per preset, or two 1024-sample IR blocks per preset).

4. **Turn Knob 1 (IR Select) to choose the IR index (1~128) to utilize the preferred IR file within your IR library.**

Use the additional knobs on pages 1~2 to fine-tune the IR settings to taste—see the following Settings table.

NOTE: Optionally, you can create a Snapshot assignment on the IR Select parameter (push and turn Knob 1 to create the Snapshot assignment—see [page 38](#)), which then allows you to change between different IRs within the block per snapshot!

Impulse Response Settings

Page	Knob	Parameter	Description
1	1	IR Sel	Selects one of the 128 available IR index locations. If a location contains an IR, its name appears in the inspector header.
	2	Low Cut	Filters a portion of the IR's bass and/or treble frequencies, which can help remove rumble and/or high-end harshness.
	3	Hi Cut	
2	1	Mix	Blends the IR signal with the dry signal passed through the IR block. When set to 0%, the path bypasses the IR completely. When set to 100%, the entire path is fed through the IR, and no dry signal is heard.
	2	Level	Adjusts the overall output level of the IR block.

IR File Reference

Once an IR block is configured to utilize an IR index slot that includes an imported IR (.wav or .hir) file, and the preset then saved, the preset creates a "reference signature" to the imported IR from its file name. Likewise, if you save your IR block as a Favorite (see [page 16](#)) or set the IR block's current settings as the User Model Defaults (see [page 17](#)), the IR block also creates a reference to the specific IR file within your IR library. Therefore, if you re-order IRs within the IR library list, your preset (or IR Favorite or User Model Default block) will still intelligently reference the originally associated IR file, even if it now resides in a different IR Library index location. This also makes it easy to share your presets with friends since they can then insert the same IR file in any slot within their device's IR library, and the preset will find it. Please also refer to the [HX Edit Pilot's Guide](#) for additional info regarding the use of IRs.

Send/Return

Each of the sends and returns can be used independently or used together as a (mono or stereo) FX loop.



FX loops let you dynamically insert your favorite external stompboxes (or rack effects) into any location in your preset.

NOTE: Each send and return pair can be set for instrument (for inserting stompboxes) or line-level operation. See "[Global Settings > Ins/Outs](#)". Send/Return blocks also offer clip indicators for level management—see [page 23](#).

Send Settings

Knob	Parameter	Description
1	Send	Adjusts the level sent to your external devices.
2	Dry Thru	Adjusts the level of the signal passed through the Send block, independent of the Knob 1 (Send) level. Normally, this should be set to 0.0dB.

Return Settings

Knob	Parameter	Description
1	Return	Adjusts the level received at the Return jack.
2	Mix	Blends the Return signal vs. the dry signal passed through the Return block. When set to 0%, the path bypasses the Return completely. When set to 100%, the entire signal is fed from the Return, and no dry thru signal is heard.

FX Loop Settings

Page	Knob	Parameter	Description
1	1	Send	Adjusts the level sent to your external device.
	2	Return	Adjusts the level received at the Return jack.
	3	Mix	Blends the FX loop signal vs. the dry signal passed through the FX Loop block. When set to 0%, the path bypasses the FX loop completely. When set to 100%, the entire path is fed through the FX loop, and no dry thru signal is heard. This means that, if you don't currently have your external gear connected to the Send & Return jacks, you won't hear any output signal unless you bypass the FX Loop block!
2	1	Trails	<i>Trails Off:</i> An external stompbox would be instantly muted when the FX Loop block is bypassed. <i>Trails On:</i> An external delay or reverb stompbox would continue to decay naturally when the FX Loop block is bypassed, or a different snapshot is selected.

Looper

HX Stomp offers two Looper types: the 1 Switch Looper and Shuffling Looper.



A Looper only functions if it has been assigned to a footswitch in Stomp mode. See ["Bypass Assign"](#) for information on how to assign blocks to footswitches. You can also access Looper functions via MIDI - see ["MIDI CC"](#).

Looper Models (Mono & Stereo)

Model	Based On*	Max. Loop Length	
		Half Speed	Full Speed
1 Switch Looper (Mono)	Line 6 Original	120 seconds	60 seconds
Shuffling Looper (Mono)	Line 6 Original	n/a	60 seconds
1 Switch Looper (Stereo)	Line 6 Original	60 seconds	30 seconds
Shuffling Looper (Stereo)	Line 6 Original	n/a	30 seconds

! IMPORTANT! You may change presets while looping, but loop playback will stop unless the preset you select includes the *same* type of looper block (same 1 Switch or Shuffling looper type, and same mono or stereo type)

Using the 1 Switch Looper

- Add a 1 Switch Looper block to your preset and assign it to a footswitch in Stomp mode.**
See ["Quick Footswitch Assign"](#).
- Press the 1 Switch Looper switch.**
The LED lights red, indicating the loop is recording.
- Press the 1 Switch Looper switch again.**
The LED lights green, indicating the loop is playing back.
- Press the 1 Switch Looper switch again.**
The LED lights amber, indicating the loop is in overdub mode. Subsequent presses of the switch toggle between play and overdub mode.
- While the Looper is in play or overdub mode, press and hold the switch for 1 second.**
The most recent recording is undone. Holding the switch again will redo the recording.

6. Quickly double-press the 1 Switch Looper switch.

Playback/recording stops, and the LED lights white, indicating a loop is in memory.

7. While Looper playback/recording is stopped, press and hold the switch.

The recording is deleted, and the LED lights dim white.



TIP: The **Command Center - HX Looper** options allow you to further customize your Stomp Mode footswitches to easily trigger multiple looper functions for the 1 Switch Looper—see [“Command Center” on page 45](#).

The 1 Switch Looper can also be controlled via external MIDI—see [“MIDI” on page 59](#).

1 Switch Looper Settings

Page	Knob	Parameter	Description
	1	Playbk	Adjusts looper playback level. You may find it useful to turn this down a bit so your live guitar can be slightly louder.
1	2	OvrDub	<i>Relatively</i> sets the level of your loop while overdubbing. For example, if your Overdub Level is set to 90%, each time your loop repeats, its volume will be reduced by 10%, sounding quieter and quieter with each overdub pass.
	3	Low Cut	Filters a portion of the loop's bass and/or treble frequencies, which can improve the mix with your live guitar.
2	1	High Cut	

Using the Shuffling Looper

Part looper, part sampler, part performance instrument—the Shuffling Looper chops up your recorded loop, randomizes the slices, and gives you control over reordering, octave shifting, reversing, repeating, and more.

1. Add a Shuffling Looper block to your preset and assign it to a foot-switch in Stomp footswitch mode.

See [“Quick Footswitch Assign” on page 41](#).

2. Turn Knob 1 (Slices) to set the number of slices your loop will be chopped into.

3. Press the switch to begin recording.

The LED lights red, indicating the loop is recording.

4. When done recording your loop, press the switch.

The LED lights green, and the sliced loop sequence immediately plays.

5. During playback, adjust the following knobs (or assign them to controllers, like expression pedals):

- **Slices**—Determines the number of slices your loop will be chopped into
- **SeqLen**—Determines the number of steps in the sequence before it loops
- **Shuffle**—Determines the likelihood of slices shuffling/reordering
- **Octave**—Determines the likelihood of slices playing back an octave higher or lower
- **Reverse**—Determines the likelihood of slices playing backward
- **Repeat**—Determines the likelihood of slices repeating
- **Smooth**—Higher values apply smoothing between slices and can give a synth-pad type quality; lower values maintain transients. Or, set it just high enough to avoid pops and clicks
- **Drift**—Determines the likelihood of a slice changing after it has played
- **Playback**—Sets the playback level of the loop sequence
- **Low Cut and Hi Cut**—Adjust these to filter some of the bass or treble frequencies of the loop playback



TIP: To only use pitch and reverse effects on your loop, turn Shuffle down to 0% and set the Slices and SeqLen to the same value.

6. Want to change it up? While the loop is playing, press the switch to randomize its slice sequence.

7. Quickly double-press the Looper switch.

Playback/recording stops, and the LED lights white, indicating a loop is in memory.

8. While the loop is playing or stopped, press and hold the switch.

The recording is deleted, and the LED lights dim white.

Split

A Split block appears any time a parallel path is created but is visible only when selected:

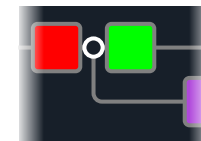

HX Stomp includes four different types of Split blocks—Y, A/B, Crossover, and Dynamic.

Turn the Upper Knob to select the Split block and then turn the Lower Knob to change the Split type.

Split > Y Settings

Knob	Parameter	Description
1	Balnce A	Adjusts the stereo balance (pan) of the signal sent to Path A (upper).
2	Balnce B	Adjusts the stereo balance (pan) of the signal sent to Path B (lower).

TIP: Okay, this one's for the power users: If you move a Split > Y block all the way left, set its BalnceA to "L100" and its BalnceB to "R100," you can process the L/MONO and RIGHT inputs independently. In addition, if you route the Mixer block to Path B (Send L/R), you can process two instruments simultaneously, each with its own mono input, stereo processing, and stereo outputs!

Split > A/B Settings

Knob	Parameter	Description
1	RoutTo	Determines the amount of the signal sent to Path A vs. Path B. Press the knob to set to Even Split.

Split > Crossover Settings

Knob	Parameter	Description
1	Freq	Any signal above this frequency is sent to Path A (upper); any signal below this frequency is sent to Path B (lower).
2	Revrse	When on, reverses the path assignments (any signal above the crossover frequency is sent to Path B, any signal below the crossover frequency is sent to Path A).

Split > Dynamic Settings

Page	Knob	Parameter	Description
	1	Threshold	Any signal below the Threshold volume level is routed to Path A; any signal above the Threshold is routed to Path B.
1	2	Attack	Determines how fast the signal is routed to Path B once reaching the Threshold.
	3	Decay	Determines how fast the signal returns to Path A once falling below the Threshold.
2	1	Reverse	When on, reverses the path assignments (any signal above the Threshold value is sent to Path B, any signal below the Threshold value is sent to Path A).

NOTE: Much like any Effects type block, a Split block can be bypassed, as well as have a bypass assignment created for it. When bypassed, regardless of the Split type in use, the block sends both left and right signals to both paths equally.

Mixer

A Mixer block appears any time a parallel path is created but is visible only when selected:



Mixer Settings

Page	Knob	Parameter	Description
	1	A Level	Adjusts the output level of Path A (upper).
1	2	A Pan	Adjusts the left/right stereo balance of Path A.
	3	B Level	Adjusts the output level of Path B (lower).
	1	B Pan	Adjusts the left/right stereo balance of Path B.
2	2	B Polari	Inverts the polarity of Path B. Typically, this should be set to "Normal."
	3	Level	Adjusts the overall output level of the Mixer block.

U.S. Registered Trademarks

All product names used in this document are trademarks of their respective owners and neither Yamaha Guitar Group nor Line 6 are associated or affiliated with them. These trademarks appear solely to identify products whose tones and sounds were studied by Line 6 during sound model development.

5150 is a registered trademark of ELVH Inc.

Acoustic is a registered trademark of GTRC Services, Inc.

Aguilar is a registered trademark David Boonshoft.

AKG and Digitech Whammy are registered trademarks of Harman International Industries, Inc.

Arbiter is a registered trademark of Sound City Amplification LLC.

Ashly is a registered trademark of Ashly Audio, Inc.

Binson, Dytronics, LA-2A and Teletronix are registered trademarks of Universal Audio, Inc.

Beyerdynamic is a registered trademark of Beyer Dynamic GmbH & Co. KG.

Bogner and Überschall are registered trademarks of Bogner Amplification.

BOSS, Space Echo, and Roland are registered trademarks of Roland Corporation U.S.

Carvin is a registered trademark of Carvin Corp.

Colorsound is a registered trademark of Sola Sound Limited Corporation, UK.

Cry Baby, Dunlop, Echoplex, Fuzz Face, MXR and Uni-Vibe are registered trademarks of Dunlop Manufacturing, Inc.

Darkglass and Microtubes are registered trademarks of Darkglass Electronics, TMI Douglas Castro.

DOD is a registered trademark of DOD Electronics Corporation.

Dr. Z is a registered trademark of Dr. Z Amps, Inc.

EBS is a registered trademark according of EBS Holding.

EchoRec is a registered trademark of Burkett, Mary A.

Electrix is a trademark or registered trademark of IVL Technologies, Ltd. in the U.S. and/or other jurisdictions.

Electro-Harmonix is a registered trademark of New Sensor Corp.

Electro-Voice is a registered trademark of Bosch Security Systems, Inc.

Eminence is a registered trademark of Eminence Speaker, LLC.

Engl is a registered trademark of Beate Ausflug and Edmund Engl.

Eventide is a registered trademark of Eventide Inc.

Fane is a trademark of Fane International Ltd.

Fender, Twin Reverb, Bassman, Champ, Deluxe Reverb, Princeton Reverb, and Sunn are registered trademarks of Fender Musical Instruments Corp.

Fulltone is a registered trademark of Fulltone Musical Products, Inc.

Gallien-Krueger is a registered trademark of Gallien Technology, Inc.

Gibson and Maestro are registered trademarks of Gibson Guitar Corp.

Heil Sound is a registered trademark of Heil Sound Ltd.

Hiwatt is a registered trademark of 9574565 Canada Inc.

Ibanez is a registered trademark of Hoshino, Inc.

Klon is a registered trademark of Klon, LLC.

Korg is a registered trademark of Korg, Inc.

Leslie is a registered trademark of Suzuki Musical Instrument Manufacturing Co. Ltd.

Marshall is a registered trademark of Marshall Amplification Plc.

Matchless is a registered trademark of Matchless, LLC.

MAXON is a registered trademark of Nisshin Onpa Co., Ltd.

Mesa/Boogie, Lone Star, and Rectifier are registered trademarks of Mesa/Boogie, Ltd.

Moog and Moogerfooger are registered trademarks of Moog Music, Inc.

Musitronics is a registered trademark of Mark S. Simonsen.

Mu-Tron is a registered trademark of Henry Zajac.

Neumann is a registered trademark of Georg Neumann GmbH.

Orange is a registered trademark of Orange Brand Services Limited.

Park is a registered trademark of AMP RX LLC.

Paul Reed Smith and Archon are registered trademarks of Paul Reed Smith Guitars, LP.

Peavey is a registered trademark of Peavey Electronics Corporation.

Revv is a registered trademark of Revv Amplification Inc.

RMC is a registered trademark of Richard McClish.

Royer is a registered trademark of Bulldog Audio, Inc. DBA Rover Labs.

Sennheiser is a registered trademark of Sennheiser Electronic GmbH & Co. KG.

Shure is a registered trademark of Shure Inc.

Silvertone is a registered trademark of Samick Music Corporation.

Supro is a registered trademark of DAG Audio Group LLC.

TC Electronic is a registered trademark of MUSIC Group IP Ltd.

Tech21 is a registered trademark of Tech21 Licensing Ltd.

Timmy is a registered trademark of Paul Cochrane AKA PAULCAUDIO.

Trainwreck is a registered trademark of of Scott Alan Fischer and Mona Fischer.

Tube Screamer is a registered trademark of Hoshino Gakki Co. Ltd.

Tycobrahe is a registered trademark of Kurt Stier.

Vox is a registered trademark of Vox R&D Limited.

Way Huge is a registered trademark of Saucy Inc.

Xotic is a registered trademark of Prosound Communications, Inc.

Snapshots

In Play view, a small camera icon appears in the upper right corner of the screen. Its number indicates the current *snapshot*.



What are Snapshots?

Imagine you have eight pet octopuses, all slithering around your amp and pedalboard. Instead of tap-dancing on your pedals (and accidentally stepping on a tentacle), you shout, "Okay, gang—here's the verse... now!" and your octopuses switch some pedals on, switch other pedals off, and tweak all your amps and pedals' knobs to make the best possible settings for your song's verse, all seamlessly with spillover delay and reverb trails. Then you shout, "Ready for the chorus... now!" and your octopuses instantly tweak everything for your song's chorus. That's the power of snapshots.

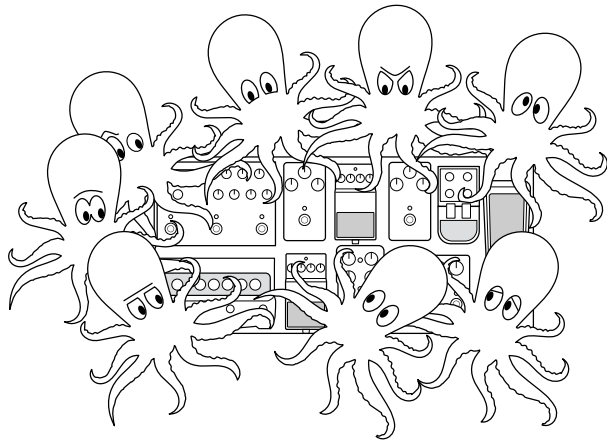

The only thing your octopuses/snapshots *can't* do is rearrange your pedalboard or swap out an effect or amp for a different one (unless both effect or amp blocks exist in the same preset).

Each preset can have up to 64 parameters assigned to Snapshots; hence, eight octopuses with eight tentacles each. The octopuses can remember three separate groups of on/off statuses and setting tweaks per preset (say, for your verse, chorus, and overindulgent noise segue); that is, HX Stomp has three snapshots per preset.

Each of the three snapshots in HX Stomp stores and recalls the state of certain elements in the current preset, including:

- **Effect Bypass**—The bypass (on/off) state of all processing blocks (The bypass state of the 1 Switch Looper is not stored/recalled via snapshot)
- **Parameter Control**—The values of any parameters assigned to controllers (up to 64 per preset)
- **Command Center**—The values of any instant MIDI CC, Bank/Prog, MMC, and HX Preset/Snapshot/Looper messages, plus the state (dim or lit) of any CC Toggle messages. See "[Command Center](#)"
- **Tempo**—The current system tempo, if "[Global Settings > MIDI/Tempo](#)" > Tempo Select is set to "Per Snapshot." (By default, it's set to "Per Preset")

Depending on how you configure them, snapshots can act as three variations of the same tone, three drastically different tones, or any combination thereof—all within the same preset. In many cases, a single preset's snapshots may accommodate all the various tones required for a song.

Using Snapshots

1. From Play view, press PAGE ▸ until you see Snapshot footswitch mode:



2. Press one of the three snapshot switches to select a different snapshot.
3. Adjust the preset by doing one or more of the following:
 - Turn one or more effects on or off by pressing stomp mode footswitches or pressing the Upper Knob in "[Edit View](#)". Snapshots remember every block's on/off state (or you can change this behavior—see "[Snapshot Block Bypass On/Off](#)").

- To adjust a parameter AND have it automatically update per snapshot, **press and turn the knob**. Snapshots remember the values of up to 64 effects parameters. The parameter's value appears white, indicating a controller's assigned to it—in this case, the Snapshots controller.

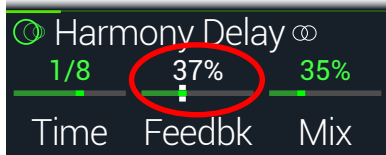

SHORTCUT: Hold ACTION and press a parameter knob to quickly remove any controller assignment (including the Snapshots controller). The value appears in color, indicating no controller is assigned to it.

NOTE: You can also manually assign the Snapshots controller. From the "[Controller Assign](#)" page, select the desired block and parameter and turn Knob 2 (Controller) to select "Snapshot."

4. Switch back to the snapshot you started with.

HX Stomp instantly and seamlessly returns to its previous state.

NOTE: If you've changed "[Global Settings > Preferences](#)" > Snapshot Edits to "Discard," you must save the preset before selecting a different snapshot; otherwise, any edits will be discarded!

Snapshot Reselect

The "[Global Settings > Preferences](#)" > Snapshot Reselect parameter adds even more flexibility to the Snapshot mode footswitches. As an example, say you're playing along on Snapshot 2 (VERSE), then you press the Snapshot 3 (CHORUS) to load it. What should happen if you press the Snapshot 3 footswitch again? With Snapshot Reselect set to the default "Reload," Snapshot 3 is simply reloaded again. But when set to "Toggle," it will now load the previously loaded snapshot (Snapshot 2, in this example)—and successive presses of the Snapshot 3 footswitch then continues to toggle between Snapshot 2 and Snapshot 3.

Snapshot Block Bypass On/Off

There may be situations where you *don't* want snapshots to control a particular block's bypass state; that is, you'd prefer to turn it on and off manually. For example, you may want manual control of a Boost block at any time without worrying whether a particular snapshot might turn it on or off.

1. Within the Edit view screen, select a processing block within the signal flow and press ACTION.
2. Press PAGE ▸ once and turn Knob 3 (Snapshot Bypass) to set the behavior for the block.

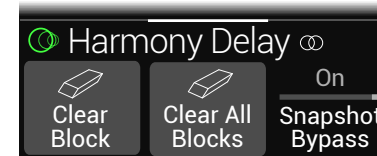

By default, all blocks are set to "On," so that snapshots automatically control their bypass state. Change to "Off" to disable snapshot control of the selected block's bypass state.

Copying/Pasting a Snapshot

Instead of creating a new snapshot from scratch, you may want to copy an existing one to another snapshot location and tweak just a few things.

1. From Snapshot mode, while touch-holding the footswitch for the snapshot you want to copy, briefly touch and release the footswitch for the snapshot you want to overwrite.

A dialog panel appears:

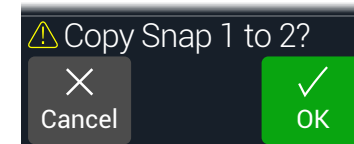

2. Press Knob 3 (OK).

NOTE: The "touch" behavior for footswitches can be disabled using the Stomp Select option in "[Global Settings > Footswitches](#)"

Swapping Snapshots

1. From Snapshot mode, simultaneously touch-hold the two foot-switches for the snapshots you wish to swap until the following dialog appears:

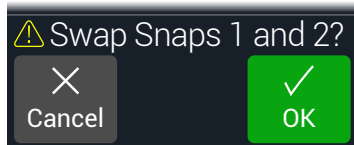

2. Press Knob 3 (OK).

Saving Snapshots

Press and ACTION together twice to save the preset.

Saving a preset stores all of its 3 snapshots automatically.

NOTE: Selecting a preset recalls the snapshot that was active when the preset was saved.

Determining Snapshot Edit Behavior

Say you're on Snapshot 1 (verse), and you change a few things—switch a delay block on, switch a mod block off, tweak a distortion's Drive parameter, etc. If you switch to Snapshot 2 (chorus) and then back to Snapshot 1 for the second verse, should HX Stomp recall those changes or return Snapshot 1 to its state when the preset was last saved? There's no right answer, therefore, HX Stomp lets you choose.

1. Press PAGE and PAGE together to open the Menu.
2. Press PAGE and then press Knob 2 (Global Settings).
3. Turn the Upper Knob to select the Preferences submenu.
4. Turn the Snapshot Edits knob to set snapshot edit behavior.
 - **Recall**—Any snapshot edits are recalled when jumping from snapshot to snapshot and appear as you *last left them* (the default).
 - **Discard**—Any snapshot edits are discarded when jumping from snapshot to snapshot and appear as the preset was last saved. If you want to save changes made to the current snapshot while Snapshot Edits is set to "Discard," **press the and ACTION buttons together twice to save before selecting another snapshot.**

The camera icon on the Play screen shows you the Snapshot Edits setting at a glance—When set to "Recall," the camera is gray; when set to "Discard," the camera is red.



NOTE: Don't forget to save before changing to a different preset to store all your snapshot settings!

Tips for Creative Snapshot Use

- The obvious use case for snapshots is designating them to specific sections of your song. For example, Snapshot 1 could be the Intro, Snapshot 2 might be the Verse, Snapshot 3 might be the Chorus.
- Turn any Delay, Reverb, and/or FX Loops blocks' Trails parameter to "On" for seamless spillover between snapshots.
- Worried that further tweaking might make your tone worse, not better? Snapshots are a great way to compare minor changes between tones without having to take your hands off the guitar.
- Set different keys in Harmony Delay blocks or intervals in Pitch blocks per snapshot.
- Having difficulty maintaining consistent volume throughout a song? Set one of the effects' Gain or Level parameter per snapshot.
- In a preset that includes a Looper block, open Command Center, and configure an Instant command with the HX Looper - Play message assigned for Snapshot 2 and with the HX Looper - Stop message assigned for Snapshot 3. Now, record a loop, and you can toggle between Snapshot 2 and 3 to play and stop your loop (along with any other actions you might additionally set to happen on these two snapshots).
- You can alternatively change snapshots via MIDI. See "[MIDI CC](#)" on page 60.

Bypass Assign

Aside from pressing the Upper Knob from Edit view, HX Stomp has a variety of additional methods for turning blocks on and off:

- Pressing a Stomp mode footswitch
- Moving a connected expression pedal (sometimes called “auto-engage”)
- Sending a MIDI CC message to HX Stomp’s MIDI In (or via USB)

Quick Footswitch Assign

1. While in Edit view, turn the Upper Knob to select the block you wish to assign to a footswitch.
2. While in Stomp footswitch mode, touch and hold FS1 or FS2 (or FS3 if Global Settings > Footswitches > FS3 Function is set to “Stomp 3”) until the following dialog appears:

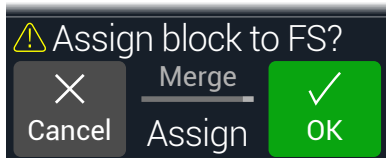

If you want to replace any other blocks that may already be assigned to the footswitch, turn Knob 2 (Assign) to “Replace.” Otherwise, leave it set to “Merge,” which allows for multiple blocks to be assigned to the same switch.

3. Press Knob 3 (OK).

NOTE: This “touch” behavior for footswitches can be disabled using the Stomp Select option in “Global Settings > Footswitches”

Manual Bypass Assign

A Stomp mode footswitch is the most obvious method for turning blocks on and off but HX Stomp can also engage or bypass a block automatically when moving an expression pedal or via external MIDI. For example, moving EXP 1 forward past the heel down position can enable a Wah or Poly Wham block, and returning EXP 1 to the heel position will bypass it again.

1. Press ◀ PAGE and PAGE ▶ together to open the Menu.

2. Press Knob 1 (Bypass Assign).

The Bypass Assign screen looks very similar to the Edit screen:

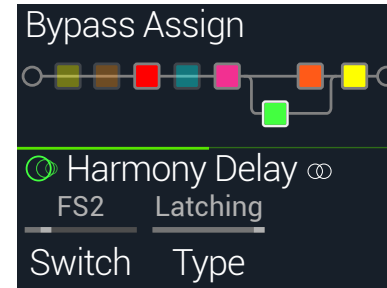

3. Turn the Upper Knob to select the block you want to bypass.

Input, Output, and Merge blocks cannot be bypassed or bypass assigned. Any Processing or Split block type can be bypassed or bypass assigned; when a Split block is bypassed, the signal is split and routed equally to both Path A (upper) and Path B (lower).

4. Turn Knob 1 (Switch) to select the desired footswitch or expression pedal.

Optionally, you can also use Knob 4 to control the block’s bypass via MIDI—see step 5.)

None Removes the bypass assignment.

FS1~FS5 Stepping on the Stomp mode footswitch turns the block on and off. Note that FS3, FS4 or FS5 won’t function unless “Global Settings > Footswitches” > FS3 [FS4, FS5] Function is set to “Stomp 3 [Stomp 4, Stomp 5].”

Selecting a footswitch displays Knob 2 (Type). Turn Knob 2 to select “Moment[ary]” or “Latching” behavior. When set to Momentary, the block is bypassed (or enabled, if already bypassed) for as long as you hold the switch. When set to Latching, the block is bypassed (or enabled, if already bypassed) every time you press the switch. **NOTE:** Footswitch type (momentary or latching) is determined per footswitch, not per assignment.

EXP 1, EXP 2 Moving the expression pedal automatically enables (or bypasses) the block.

Selecting EXP 1 or 2 displays Knob 2 (Position) and Knob 3 (Wait). Position determines at which point within the expression pedal’s travel the block is enabled or bypassed. 0% is heel down; 99% is toe down. Wait determines how long HX Stomp waits before bypassing the block; for example, you wouldn’t want the wah to turn off every time you touched the heel down position in your big funk wah solo.*

TIP: By default, bypass toggling for the block via EXP 1 or EXP 2 is configured for “heel down = off” behavior. To reverse bypass behavior, press the Upper Knob (bypass). In such a case, the block will be bypassed when moving the expression pedal past the configured Position location. Since it is possible to configure the bypass of multiple blocks to be assigned to an expression pedal, you can set each block’s Position value differently - thereby allowing the pedal to turn some blocks on and others off at different positions in the pedal’s travel.

SHORTCUT: Alternatively, press PAGE ▸ , press Knob 3 (Learn) and then either move the desired expression pedal or send the desired MIDI CC message from your MIDI controller. HX Stomp automatically selects it.

5. If desired, press PAGE ▸ and turn Knob 1 (MIDI In) to assign an incoming MIDI CC message to turn the block on and off.

Incoming CC values 0-63 turn the block off; values 64-127 turn the block on. Note that some MIDI CCs are reserved for global functions and cannot be selected - see [“MIDI CC”](#).

Clearing Bypass Assignments

1. From the Bypass Assign screen, select the block whose bypass assignment you want to clear and press ACTION.
2. Press Knob 1 (Clear Assignments).

Clearing All Bypass Assignments

1. From the Bypass Assign screen, press ACTION.
2. Press Knob 2 (Clear All Assignments) to clear all blocks’ Bypass assignments.

The following dialog appears:

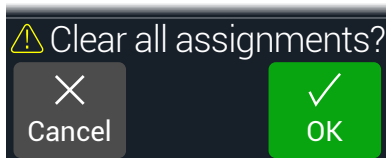

3. Press Knob 3 (OK).

Swapping Stomp Footswitches

If you want to change the location of Stomp mode footswitches (especially those with multiple items assigned), instead of manually reassigning everything, you can quickly swap all assignments between two stomp footswitches.

1. Touch (but don’t press) any two Stomp footswitches until the following dialog appears:

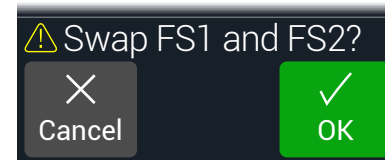

2. Press Knob 3 (OK).

Tips for Creative Bypass Assignment

- If you find yourself constantly toggling one switch off and another on, assign both blocks to the same footswitch, and while one is selected, press the Upper Knob. Now pressing the footswitch will toggle one off and the other on simultaneously.
- Assign a Wah block to be engaged only when moving an expression pedal past 1%. Set the Wait time long enough so that natural foot movements don’t turn the wah off every time you reach the heel-down position, but no so long that it turns off noticeably late when you rest the expression pedal at heel-down - See [“Manual Bypass Assign”](#).
- Different blocks can be enabled or bypassed at different locations of an expression pedal’s travel. Experiment with turning on multiple overdrive blocks—one at Position 5%, another at Position 30%, another at Position 70%, and so on.
- When using a footswitch to toggle between two Amp or Amp+Cab blocks, the amp models may sound notably different from one another (just like real amps!). Use an EQ block to make one Amp block sound a bit closer to the other Amp block and assign its bypass to the same footswitch.
- Assign a delay block with very high feedback to be turned on only when reaching the toe position of an expression pedal. Squeals galore.

Controller Assign

HX Stomp provides a wide variety of tools for controlling your tone during a performance. The most obvious controller would be a connected expression pedal (often assigned to Wah, Pitch Wham, or Volume), but you may also assign footswitches to toggle between two values of a given parameter or parameters or even have parameters instantly change when selecting different snapshots within a preset. Practically any block's parameters can be configured for external MIDI CC control as well.

If a parameter has a controller assigned, its value appears with white text:

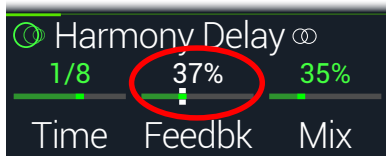

IMPORTANT! Adding a Wah, Pitch Wham, or Poly Wham block automatically assigns it to be controlled by EXP 1. Adding a Volume or Pan block automatically assigns it to be controlled by EXP 2. With a [Mission SP1-L6H Line 6 Expression Pedal](#), connecting it to HX Stomp with a Y-cable will just work, and its built-in toe switch will toggle between any Wah/Pitch Wham/Poly Wham and Volume/Pan blocks. See [page 53](#).

Assigning a Controller

1. From Stomp mode, press and hold the knob for the parameter you wish to control.

HX Stomp jumps to the Controller Assign page and displays your parameter at Knob 1 (Parameter).

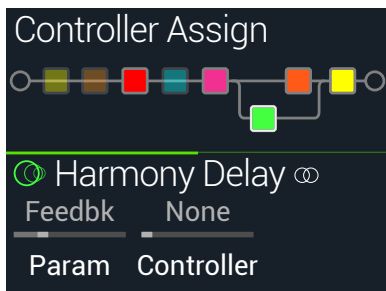

NOTE: To manually access the Controller Assign menu, press and then Knob 2 (Controller Assign).

2. Press PAGE and then press Knob 3 (Learn).

The button's brain icon glows blue.

3. Step on a footswitch, move a connected expression pedal, send a MIDI CC message from your external MIDI controller device, computer software, etc.

The controller name appears above Knob 2 (Controller).

NOTE: To manually select a controller, turn Knob 2 (Controller).

- None** Removes the controller assignment.
- EXP 1 or 2** Expression pedals are the most common type of controller, used to control Volume, Wah, Pitch Wham, etc.
- FS1~FS5** Stepping on a Stomp mode footswitch can toggle between a parameter's min and max values.

Selecting FS1~FS5 will display Knob 3 (Switch Type). **Turn Knob 3 to select "Moment[ary]" or "Latch[ing]" behavior.** Momentary means the value will change for as long as you hold the switch. Latching toggles between Min and Max values every time you press the switch.
- MIDI CC** Selecting "MIDI CC" will display Knob 3 (CC#). **Turn Knob 3 to select the desired MIDI CC number.****
- Snapshot** Although all controller-assigned parameters are updated per snapshot, an additional "Snapshots" controller is available when other controllers are already used.

***NOTE:** Footswitch behavior (momentary or latching) is determined per footswitch, not per assignment.

****NOTE:** HX Stomp has reserved specific MIDI CC messages for global functions; these CCs cannot be used as controllers. If you attempt to learn a CC message reserved for global functions, the following dialog appears:

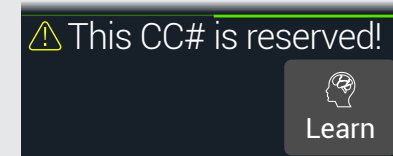

See ["MIDI CC"](#) for more information.

- If desired, press PAGE ▸ and turn Knob 1 (Min Value) and Knob 2 (Max Value) to set the range you wish to control.

 **TIP:** To reverse controller behavior, swap the min and max values.

When returning to the Home screen, the assigned parameter appears with its value in white text to indicate a controller assignment.

For any footswitch or pedal type controller assignment, the Min and Max values are indicated with white dots.

For a snapshot assignment, white indicators appear above and below the slider's value, as shown below.

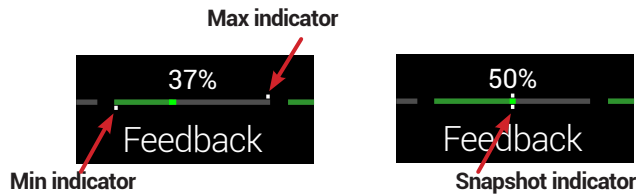

- Press  to return to the Home screen.

 **SHORTCUT:** To assign a parameter to the Snapshots controller, it's even easier—just push and turn the parameter's knob. The value appears in white text, indicating it's now assigned to a controller.

 **SHORTCUT:** Hold ACTION and press a parameter knob to quickly remove any controller assignment (including the Snapshots controller). The value's text changes from white back to its original color, indicating no controller is assigned.

Clearing a Block's Controller Assignment(s)

- From the Controller Assign screen, select the block whose controller assignments you want to clear and press ACTION.
- Press Knob 1 (Clear Controller).

Clearing All Controller Assignments

- From the Controller Assign screen, press ACTION.
- Press Knob 2 (Clear All Controller) to clear all blocks' controller assignments.

The following dialog appears:

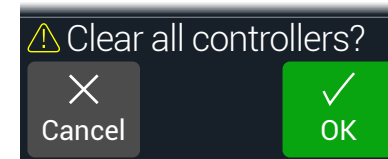

- Press Knob 3 (OK).

 **IMPORTANT!** Clearing All Controller Assignments also removes the Wah and Volume assignments from EXP 1 and EXP 2. Use this function with caution!

Tips for Creative Controller Assignment

- By default, a parameter's Min and Max values will be pretty extreme. It pays to play pretty conservatively here, as subtle parameter adjustments go a long way.
- To smoothly blend between the tone on parallel paths A and B, select a Split > A/B block and assign the Route To parameter to an expression pedal. By default, a heel-down position means the signal passes fully through Path A. Moving the pedal toward the toe-down position will gradually crossfade into Path B. Alternatively, assign a footswitch to control the Route To parameter for instantly switching back and forth.
- If you're looking for an ultra-clean boost, instead of adding a Volume/Pan > Gain block, try assigning a footswitch to increase the Level parameter of a Mixer or Output block.
- If you have a favorite delay or reverb pedal, use an FX Loop block to insert it into your tone. Assign EXP 1 or 2 to control the block's Mix parameter, which will smoothly blend the pedal into your tone.
- For extreme psychedelic dub delay squeals, assign a footswitch to both increase a Delay's feedback, and decrease its time.
- Assign a footswitch to toggle between two Delay > Time parameter values, such as 1/4 and 1/8 dotted.
- Assign IR Select to a footswitch. Set the two IRs as min and max values. Now you can instantly toggle between them.

Command Center

HX Stomp is also capable of acting as a master remote control for your other live performance or studio gear. Each of its Stomp mode footswitches and expression pedals can be used to send a variety of messages:

- Transmit MIDI CC, Program Change, Note, and MMC commands to your guitar amps, pedals, synths, or even other modelers.
- Send QWERTY Hotkey messages, emulating a computer keyboard, to practically any software to control it from your device (see [“QWERTY Hotkey Commands” on page 46](#)).
- Configure footswitches to expand your device’s Stomp mode with additional control functions (see [“HX Preset, Snapshot, and Looper Commands” on page 46](#)).
- In addition, up to six “Instant” ⚡ commands can be transmitted automatically when an HX Effects preset is recalled, for starting your DAW, triggering a MIDI-controlled lighting system, or switching presets on external gear.

All Command Center assignments are stored per preset, but they can be copied and pasted to other presets (see [“Copying and Pasting a Command”](#)).

NOTE: The Value parameters of any instant MIDI CC, Bank/Prog, MMC, and HX Looper messages, plus the state (dim or lit) of any CC Toggle messages, are automatically recalled when selecting a snapshot.

NOTE: By default, all MIDI-based Command Center messages are transmitted via MIDI and USB simultaneously. You can customize MIDI behaviors using the [“Global Settings > MIDI/Tempo”](#) options.

Assigning a Command

1. Press **◀ PAGE** and **PAGE ▶** together to open the Menu.
2. Press **Knob 3 (Command Center)**.

Any switches, pedals, or instant locations with commands assigned appear with turquoise triangles above them:

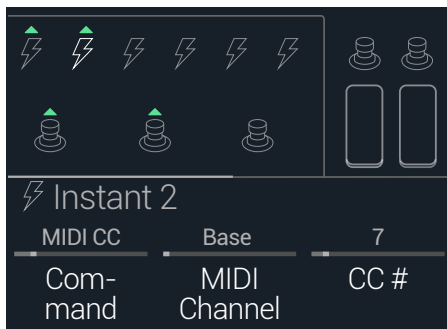

3. Turn the upper knob to select the footswitch, pedal, or instant location you wish to use to send the command.
4. Turn **Knob 1 (Command)** to select the type of command you wish to transmit.

Not all command sources can send the same types of commands.

Select “None” to remove any command assignment.

5. Press **◀** or **▶** and turn **Knobs 1-3** to adjust the command’s settings, which are determined by the type of command selected:

MIDI CC (Continuous Controller)			
Page	Knob	Parameter	Description
1	2	MIDI Channel	Sets the CC message’s MIDI channel (1-16). When set to “Base,” the HX Effects device follows the Global MIDI channel, which is set from the “Global Settings > MIDI/Tempo” page.
	3	CC #	Sets the CC number (0-127).
2	1	Value, Min Value	Sets the CC number’s value (0-127). For EXP Pedal 1 and 2, sets the minimum CC value controlled by the pedal.
	2	Max Value	For EXP Pedal 1 and 2, sets the maximum CC value controlled by the pedal.
CC Toggle			
Page	Knob	Parameter	Description
1	2	MIDI Channel	Sets the CC messages’ MIDI channel (1-16). When set to “Base,” the HX Effects device follows the Global MIDI channel, which is set from the “Global Settings > MIDI/Tempo” page.
	3	CC #	Sets the CC number (0-127).
2	1	Dim Value	Sets the CC number’s value (0-127) when the footswitch ring is dim.
	2	Lit Value	Sets the CC number’s value (0-127) when the footswitch ring is lit.
	3	Type	Sets the footswitch behavior as either “Latching” (the default) or “Momentary.”

NOTE: For CC Toggle commands, one of two values is automatically transmitted upon preset recall, determined by the footswitch’s state (dim or lit) when the preset was saved. Subsequent presses of the footswitch toggle between the two states’ CC values—Dim Value and Lit Value.

Bank/Prog (Program Change)			
Page	Knob	Parameter	Description
1	2	MIDI Channel	Sets the Bank/Program message's MIDI channel (1-16). When set to "Base," the HX Effects device follows the Global MIDI channel, which is set from the "Global Settings > MIDI/Tempo" page.
	3	Bank CC00	Sets the CC#00 (Bank MSB) value. Select "Off" if the receiving device shouldn't respond to Bank MSB.
2	1	Bank CC32	Sets the CC#32 (Bank LSB) value. Select "Off" if the receiving device shouldn't respond to Bank LSB.
	2	Program	Sets the Program Change (PC) value. Select "Off" if you only want to send a Bank MSB and/or Bank LSB message.

Note On			
Page	Knob	Parameter	Description
1	2	MIDI Ch	Sets the note's MIDI channel (1-16). When set to "Base," the HX Effects device follows the Global MIDI channel, which is set from the "Global Settings > MIDI/Tempo" page.
	3	Note	Sets the MIDI note value (C-1 ~ G9). Middle C is C3.
	1	Velocity	Sets the MIDI note's velocity (0-127).
2	2	Note Off	Determines whether the MIDI note sustains until pressing the switch again (Latching) or sustains only while the switch is held (Momentary).

MMC (MIDI Machine Control)		
Knob	Parameter	Description
2	Message	Determines the message type.

QWERTY Hotkey Commands

QWERTY hotkeys (computer keyboard shortcuts with or without modifiers, such as Shift, Control, Option/Alt, and Command) can also be sent to your Mac, PC, or iOS device via USB, allowing you to control virtually any DAWs, YouTube, Spotify, looping software, DJ software, media players, lighting software, and more!

QWERTY command assignments can be made to any footswitch or any Instant ⚡ command, allowing them to be sent automatically from any preset or snapshot recall. These commands can be assigned on HX Stomp using the preceding steps within this chapter (but you'll likely find it faster and easier using the HX Edit app).

Just like a standard computer keyboard, hotkeys won't work unless the software or app you want to control is in focus.

QWERTY Hotkey			
Page	Knob	Parameter	Description
1	2	Modifier 1	Set up to three key modifier(s) to be sent with the key-stroke: Choose Shift, Alt, Ctrl, or Mac/PC (corresponds to the "Windows" key on Windows OS systems, and the "Command" key on macOS systems).
		Modifier 2	
	1	Modifier 3	
2	2	Keystroke	Sets the alpha, numeric, or other computer keyboard keystroke value to be sent.
	3	Type	Sets the footswitch type to either Momentary or Latching.

HX Preset, Snapshot, and Looper Commands

These "HX" commands allow you to configure Stomp mode switches for even greater control of your device's internal functions. HX commands can be assigned on HX Stomp using the preceding steps (see ["Assigning a Command"](#)). All assignments are saved per preset.

NOTE: Although Stomp mode switches can be assigned to multiple functions, to avoid unintended behavior, we strongly recommend the HX Preset, HX Snapshot, and HX Looper commands are assigned only to empty footswitches.

HX Preset

The HX Preset command allows you to configure a Stomp mode footswitch to immediately "jump to" any other preset.

HX Preset		
Knob	Parameter	Description
2	Preset	Sets the preset to be selected by the command: Next, Previous, or a preset's number (01A~42C).

HX Snapshot

The HX Snapshot command allows you to configure a Stomp mode footswitch to recall any snapshot within the current preset immediately.

1. From the Command Center page, select a footswitch and turn Knob 1 (Command) to “Snpsht.”
2. Turn Knob 2 (Behavior) to either “Prs/Rel” (Press/Release) or “Prs/Hld” (Press/Hold)
3. Turn the other two knobs to configure which snapshots are recalled per the “Press” and the “Release” (or “Hold”) of the footswitch, respectively.

HX Snps (Snapshots)			
Page	Knob	Parameter	Description
1	2	Behavior	Sets the behavior for the footswitch. This allows you to recall the desired snapshot index number, or Next or Previous snapshot, <i>independently</i> per each Press and Release , or each Press and Hold of the footswitch. (Note that the assigned, Stomp mode footswitch's label and LED will only indicate the command assigned to the Press function.)
	3	Press	Sets the snapshot to be recalled on the Press action of the footswitch.
2	1	Release/Hold	Sets the snapshot to be recalled on the Release (or Hold, depending on your page 1, knob 2 selection) of the footswitch.

HX Looper

For a preset that includes a Looper block, this command allows you to configure an Instant ⚡ or Stomp mode footswitch to trigger any function of the Looper.

 **NOTE:** A 1 Switch Looper block must be present in your preset for HX Looper commands to function.

HX Looper - Instant Command Assignment:

1. In the Command Center window, select an Instant ⚡ command controller and turn Knob 1 (Command) to “Looper.”

2. Turn Knob 2 (Function) to choose the specific Looper function you wish to trigger.

The selected **Function** action is automatically stored and recalled per snapshot. This allows you to record a loop and, for example, configure an Instant command to automatically “Play” the Loop when loading one Snapshot and “Stop” when loading a different Snapshot.

HX Loop (Looper) - Instant ⚡ Command		
Knob	Parameter	Description
2	Function	Sets the Looper action to be triggered: Play, Stop, Play/Stop, Rec, Overdub, Record/Overdub, Play Once, Reverse, Forward, Reverse/Forward, Half Speed, Full Speed, Toggle Speed, or Undo.

HX Looper - Footswitch Assignment:

1. In the Command Center window, select a footswitch and turn Knob 1 (Command) to “Looper.”
2. Turn Knob 2 (Behavior) to either “Prs/Rel” or “Prs/Hld.”
3. Turn the other knobs to configure which Looper commands are sent per the “Press” and the “Release” (or “Hold”) of the footswitch, respectively.

The selected **Behavior**, **Press**, and **Release/Hold** actions are automatically stored and recalled per snapshot.

HX Loop (Looper) - Footswitch			
Page	Knob	Parameter	Description
1	2	Behavior	Sets the behavior for the footswitch. This allows you to send up to two different Looper commands, <i>independently</i> per each Press and Release or each Press and Hold of the footswitch. (Note that the assigned, Stomp mode footswitch's label and LED will only indicate the command assigned to the Press function.)
	3	Press	Sets the Looper command to be sent on the Press action of the footswitch.
2	1	Release/Hold	Sets the Looper command to be sent on the Release (or Hold, depending on your page 1, knob 2 selection) of the footswitch.

Note that the assigned, Stomp mode footswitch's label and LED will only indicate the command assigned to the **Press** function.

Copying and Pasting a Command

1. Select the location containing the command you wish to copy and press ACTION.
2. Press Knob 1 (Copy Command).
3. Select the location to which you want to paste the command—even in a different preset—and press ACTION.
4. Press Knob 3 (Paste Command).

Copying and Pasting All Commands

Setting up the same or similar set of commands across multiple presets can quickly become tiresome. Fortunately, HX Stomp lets you quickly copy and paste all commands to another preset.

1. From the Command Center page, press ACTION.
2. Press Knob 2 (Copy All Commands).
3. Select the preset to which you want to paste the commands and press ACTION.
4. Press Knob 3 (Paste All Commands).

Clearing a Command

1. Select the location containing the command you want to clear and press ACTION.
2. Press Page 2, Knob 1 (Clear Command).

Clearing All Commands

1. From the Command Center page, press ACTION.
2. Press Page 2, Knob 2 (Clear All Commands).

The following dialog appears:

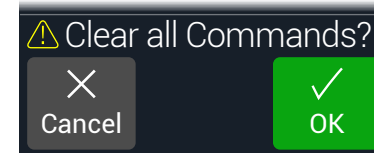

3. Press Knob 3 (OK).

Global EQ

The Global EQ built into HX Stomp has three fully parametric bands plus variable low and high cut filters, and is used for compensating for the wide disparity in acoustic environments on tour or when traveling from studio to studio. Global EQ is applied to all presets.

 **NOTE:** Global EQ is never heard from the Send or USB outputs.

1. Press **◀ PAGE and PAGE ▶** together to open the Menu.
2. Press **Knob 3 (Global EQ)**.

The Global EQ screen appears:

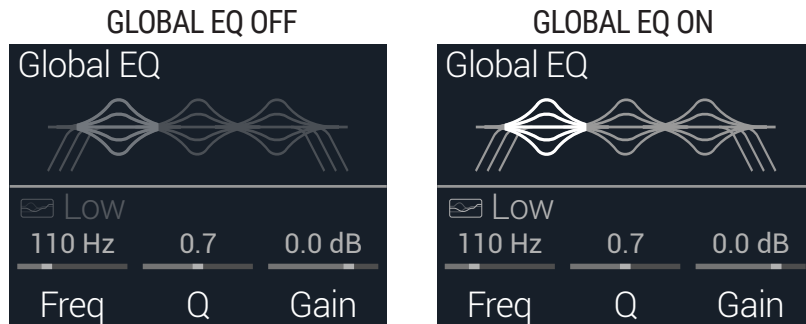

3. Press the **Upper Knob** to turn Global EQ on and off.
4. Turn the **Upper Knob** to select the desired EQ band—Low Cut, Low, Mid, High, or High Cut.
5. Turn **Knobs 1-3** to adjust the selected EQ band.

Resetting Global EQ

Resetting the Global EQ returns its settings to factory default (flat).

1. From the **Global EQ screen**, press **ACTION**.
2. Press **Knob 1 (Reset EQ)**.

The following dialog appears:

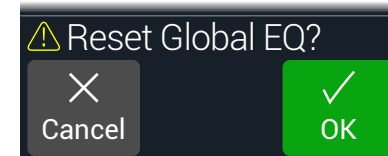

3. Press **Knob 3 (OK)**.

Global Settings

The Global Settings menu contains additional parameters that apply to all presets, such as input and output levels, footswitch configurations, etc.

1. Press ◀ PAGE and PAGE ▶ together to open the Menu.
2. Press PAGE ▶ and then press Knob 2 (Global Settings).

The Global Settings screen appears:

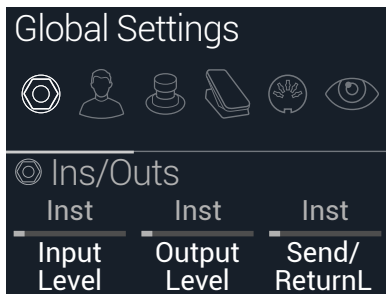

3. Turn the Upper Knob to select one of the six submenus.
If necessary, press PAGE ▶ to view more parameters.

 **NOTE:** See the next page for a description of all Global Settings.

Setting Proper Levels

The various inputs and outputs should be set to match that of your instrument, amp, and other pedals to ensure an ideal tone, low noise, and no ugly clipping distortion—please see [“Signal Present and Clip Indicators” on page 23](#) (unless, of course, you want ugly clipping distortion. Who are we to judge?). Just know that if you run to the internet, screaming, “HX Stomp sounds bad!” the first thing people will ask is if you read this section of the manual. And if you didn’t, they’ll make fun of you.

1. From the Global Settings menu, turn the Upper Knob to select the Ins/Outs submenu.
2. Using Knobs 1 and 2, set levels according to the following table:

Jack	What are you connecting?	Then do this:
INPUT L/MONO, RIGHT	Guitar or bass with passive pickups	Set Input Level to “Inst”
	Guitar or bass with really loud active pickups	Set Input Level to either “Inst” or “Line” (trust your ears)
	Keyboard, synth, or drum machine	Set Input Level to “Line”
OUTPUT L/MONO, RIGHT	To the Guitar In on a guitar or bass amp	Set Output Level to “Inst”
	To the guitar input(s) of a stompbox or other multieffect	
	To the instrument-level effects return of a guitar or bass amp for post effects or 4-cable method	
	To the line-level effects return of a guitar or bass amp for post effects or 4-cable method	Set Output Level to “Line”
To the inputs of a studio rack effect or mixer		

Resetting All Global Settings

Resetting the Global Settings returns them to factory default. Performing this reset does not affect any presets you may have created.

1. From the Global Settings menu, press ACTION.
2. Press Knob 1 (Factory Settings).

The following dialog appears:

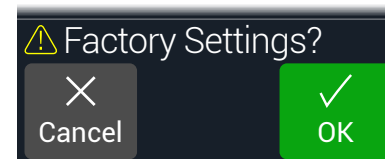

3. Press Knob 3 (OK).

Global Settings > Ins/Outs

Page	Knob	Parameter	Description
1	1	Input Level	Choose "Inst[rument]" when connecting a guitar, bass, or stompboxes to HX Stomp's input jack(s); choose "Line" when connecting synths, drum machines, the sends from mixers, or other line-level sources. If your guitar or bass has really loud active pickups (or if you just happen to prefer the sound of a "padded" input level for your instrument), choose "Line" - Or, just try both and trust your ears.
	2	Output Level	Choose "Inst[rument]" when connecting the 1/4" outputs to stompboxes or the front of guitar amps; choose "Line" when connecting to mixers or standalone recorders. When using a single amp or mixer channel, connect only the LEFT/MONO 1/4" jack.
	3	Send/ReturnL	Choose "Inst[rument]" when using a Send/Return pair as an FX loop for stompboxes; choose "Line" when using a Send/Return pair as an FX loop for line-level rack processors or as additional inputs and outputs for connecting keyboards, drum machines, mixers, and other gear.
1	Send/ReturnR		
2	2	Return Type	Determines whether the signal received at the Return jacks should be used for Return and FX Loop blocks—or—act as a stereo Aux In (no processing) for jamming along with mixers, MP3 players, etc. To utilize the Return jacks for an unprocessed Aux In, set the preset's Input block to "Main L/R" - this allows your instrument signal (connected via the Main L/R input) to be heard simultaneously along with the (unprocessed) Return L/R signal for jamming along.
	3	USB In 1/2 Trim	Sets the level of incoming audio from USB 1/2, which bypasses all HX Stomp processing. Normally, this should be left at 0.0dB.
3	1	Phones Monitor	Determines which signal(s) are heard from the Phones output. Normally you would set this to "Main L/R."
	2	Volume Controls	Determines whether the top panel VOLUME knob controls both the 1/4" main output and headphone output ("Main+HP") or just the headphone output ("Phones"). When set to "Phones" the 1/4" main outputs remain at unity gain.

Global Settings > Preferences

Page	Knob	Parameter	Description
1	1	Bypass Type	When pressing the Upper and Lower knobs together (or a footswitch assigned to “All Bypass”), HX Stomp bypasses all blocks. There are two types of All Bypass in HX Stomp—Choose “Analog” if you want your guitar’s signal routed directly from the HX Stomp inputs to its outputs, with no processing or A/D/A conversion (also called “true bypass”). Choose “DSP” if you want delay echoes and reverb tails to decay naturally when HX Stomp is bypassed.
	2	Snapsht Edits	Determines whether any edits made to a snapshot (block on/off, parameter control, tempo) are remembered when returning to that snapshot. When set to “Recall,” any snapshot edits are recalled when jumping from snapshot to snapshot and appear as you last left them. When set to “Discard,” any snapshot edits are discarded when jumping from snapshot to snapshot and appear as the preset was last saved. If you want to save changes made to a snapshot while Snapshot Edits is set to “Discard,” press SAVE twice before selecting another. See “Determining Snapshot Edit Behavior” .
	3	Tempo Pitch	Determines how delay repeats behave when repeatedly pressing TAP. “Authentic” [Authentic] respects the natural pitch fluctuations inherent when changing a real delay pedal’s time knob; “Transpr” [Transparent] minimizes these artifacts.
2	1	EXP/FS Tip	Determines whether the rear panel PEDAL jack’s Tip signal is an Expression Pedal 1 input jack or a Footswitch 4 input jack.
	2	EXP/FS Ring	Determines whether the rear panel PEDAL jack’s Ring signal is an Expression Pedal 2 input jack or a Footswitch 5 input jack.
	3	Tip Polarity	If your external expression pedal or footswitch appears to work backward—for example, a Volume pedal block is loudest with the heel all the way down, or if your FS4 or FS5 assigned function is not performing as expected when toggled via your external footswitch—set its polarity to “Invert.”
3	1	Ring Polarity	
	2	Preset Number	Determines whether presets appear as 42 banks of three (A B C) or are numbered 000-125 (convenient when recalling presets via MIDI program change messages).
3	3	Snapshot Reselect	Determines the behavior when pressing a Snapshot mode footswitch again after loading its assigned snapshot. “Reload” (the default) simply reloads the stored state of the footswitch’s assigned snapshot again. “Toggle Previous” toggles between loading the previously selected snapshot and the footswitch’s assigned snapshot.
	1	Auto In-Z	Determines how the input’s impedance circuit behaves when the Input block > Input Main L/R > In-Z is set to “Auto.” When set to “First Block” (the default), the impedance circuit reflects the first block’s impedance within the signal path, regardless of whether it’s enabled or bypassed. When set to “First Enabled,” the impedance circuit reflects the impedance of the first enabled block in the signal path. Also, see “Input Settings” on page 22 .

Global Settings > Footswitches

Page	Knob	Parameter	Description
	1	Stomp Select	When set to "Touch," touching a Stomp mode switch selects its assigned item(s), but pressing doesn't. When set to "Press," pressing a Stomp mode switch selects its assigned item(s), but touching doesn't (helpful if you insist on playing barefoot). When set to "Both," either touching or pressing will select the assigned item. The default is "Touch."
1	2	FS3 Function	Sets the function of Footswitch 3. Choose from TAP/Tuner, Stomp 3, Preset Up, Preset Down, Snapshot Up, Snapshot Down, All Bypass, or Toggle EXP 1/2. The default is TAP/Tuner.
	3	FS4 Function	Sets the function of Footswitch 4, but only when Global Settings > Preferences > EXP/FS Tip is set to "FS4." (It's set to "EXP 1" by default, so you must change this to "FS4" for FS4 Function to work properly!) Choose from TAP/Tuner, Stomp 4, Bank Up, Bank Down, Preset Up, Preset Down, Snapshot Up, Snapshot Down, Next Footswitch Mode (same as pressing PAGE ▷ from Play view), Previous Footswitch Mode (same as pressing ◀ from Play view), All Bypass, or Toggle EXP 1/2.* The default is "All Bypass."
2	1	FS5 Function	Sets the function of Footswitch 5, but only when Global Settings > Preferences > EXP/FS Ring is set to "FS5." Choose from TAP/Tuner, Stomp 5, Bank Up, Bank Down, Preset Up, Preset Down, Snapshot Up, Snapshot Down, Next Footswitch Mode (same as pressing PAGE ▷ from Play view), Previous Footswitch Mode (same as pressing ◀ from Play view), All Bypass, or Toggle EXP 1/2.* The default is "Tog[EXP[1/2]."

*For connecting an external footswitch to access the FS4 or FS5 functions, the use of a momentary (unlatched) type footswitch is recommended. Connect to the EXP1/2, FS 4/5 input while the device is powered off to avoid toggling the current FS 4/5 setting.

Mission Helix Expression Pedal

By default, the HX Stomp EXP 1/2 | FS4/5 jack is set up to accommodate the [Mission Helix expression pedal](#), connected via an optional Y cable (sometimes called a TRS insert cable). The main advantage of this setup is that pressing the integrated toe switch will not only toggle the pedal's function between EXP 1 (Wah/Pitch Wham/PolyWham/PolyBass Wham) and EXP 2 (Volume Pedal/Pan), but it will also toggle the appropriate blocks on and off.

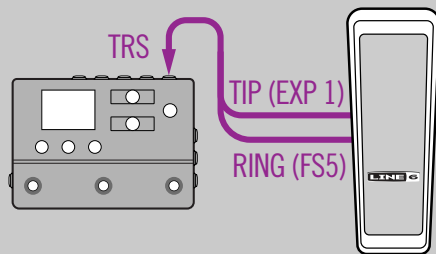

One Expression Pedal

When connecting one traditional expression pedal, there are a few things to be aware of:

- From the ["Controller Assign"](#) menu, **assign the Position parameter of Volume Pedal and Pan blocks to "EXP 1"**
- From the ["Bypass Assign"](#) menu, **assign the Switch parameter of Volume Pedal and Pan blocks to "None"**
- From the ["Bypass Assign"](#) menu, **assign the Switch parameter of Wah and Pitch or Poly Wham blocks to either "EXP 1" (where HX Stomp engages the block when moving EXP 1 away from its heel down position) or a stomp footswitch**

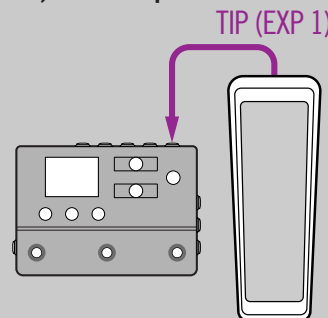

Two Expression Pedals

When connecting two traditional expression pedals with a Y cable, there are a few things to be aware of:

- Set ["Global Settings > Preferences"](#) > EXP/FS Ring to "EXP 2"
- From the ["Bypass Assign"](#) menu, **assign the Switch parameter of Volume Pedal and Pan blocks to "None"**
- From the ["Bypass Assign"](#) menu, **assign the Switch parameter of Wah and Pitch or Poly Wham blocks to either "EXP 1" (where HX Stomp engages the block when moving EXP 1 away from its heel down position) or a stomp footswitch**

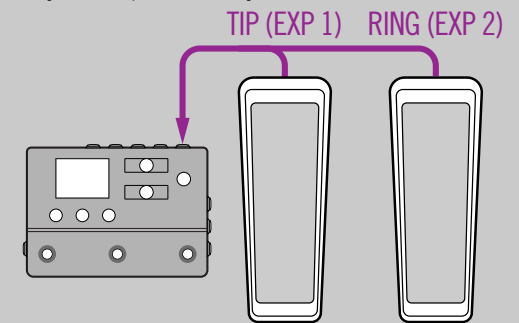

Global Settings > EXP Pedals

Page	Knob	Parameter	Description
1	1	EXP 1 Position	Determines whether each expression pedal position is recalled per snapshot, per preset, or applied globally. If you want a Volume Pedal or Wah to maintain its position when switching presets, set this to "Global."
	2	EXP 2 Position	

Global Settings > MIDI/Tempo

Page	Knob	Parameter	Description
1	1	MIDI Base Channel	Sets the system base MIDI channel that HX Stomp uses to both send and receive MIDI communication via MIDI and USB.
	2	MIDI Thru	When on, MIDI OUT also acts as a MIDI THRU; that is, it passes through any MIDI messages received at the MIDI IN jack.
	3	Rx MIDI Clock	Determines whether HX Stomp responds to incoming MIDI beat clock received at its MIDI IN port, via USB, or whichever it senses first ("Auto"). If you don't want HX Stomp to respond to MIDI clock at all, set this to "Off."
2	1	Tx MIDI Clock	Determines whether HX Stomp transmits MIDI beat clock from its MIDI OUT port, via USB, or both. If you don't want HX Stomp to transmit MIDI clock at all, set this to "Off."
	2	Tempo Select	Choose whether the tempo is stored and recalled with each snapshot, recalled with each preset, or is applied globally across all presets and snapshots.
	3	BPM	Depending on the Knob 2 (Tempo Select) setting, this Beats Per Minute tempo value is saved per snapshot, per preset, or globally.
3	1	USB MIDI	When on, HX Stomp receives and transmits MIDI data via USB in the same capacity as its MIDI jacks.
	2	MIDI PC Rx	Determines whether or HX Stomp responds to incoming MIDI program change (PC) messages from its MIDI IN port, via USB, or both MIDI and USB. If you don't want HX Stomp to respond to PC messages at all, set this to "Off."
	3	MIDI PC Tx	Determines whether HX Stomp automatically sends MIDI program change (PC) messages from its MIDI OUT port, via USB, or both MIDI and USB when selecting presets.

Global Settings > Displays

Knob	Parameter	Description
1	LED Rings	Determines whether the Stomp mode footswitches' colored LED rings appear dim when bypassed ("Dim/Br"), or off when bypassed ("Off/Br"). When playing in bright sunlight, you may want to set this to "Off/Br" to increase contrast.
2	Tap LED	If you'd prefer not to see the red TAP LED constantly flashing, you can turn it off.

USB Audio

HX Stomp functions as a USB 2.0, multichannel, 24-bit/96kHz, low-latency audio interface for Windows and Mac computers, as well as for iPad and iPhone mobile devices (with optional Apple Camera Connection Kit adapter), and is compatible with all major DAW software. Refer to the illustration and tables below for a description of how audio is handled between HX Stomp and your computer.

NOTE: For USB audio operation:
 For Windows computers, it is necessary to download and install the Line 6 Helix ASIO driver (see [page 57](#)).
 For Mac computers, it is only necessary to download and install the Line 6 Mac Core Audio driver if you desire audio sample rate operation at rates other than 48kHz (see [page 57](#)).
 For iPad or iPhone mobile devices, there is no driver installation necessary.
 All drivers are available from line6.com/software. Please refer to HX Stomp firmware *Release Notes* for driver support specific to the latest Windows and Mac operating systems.

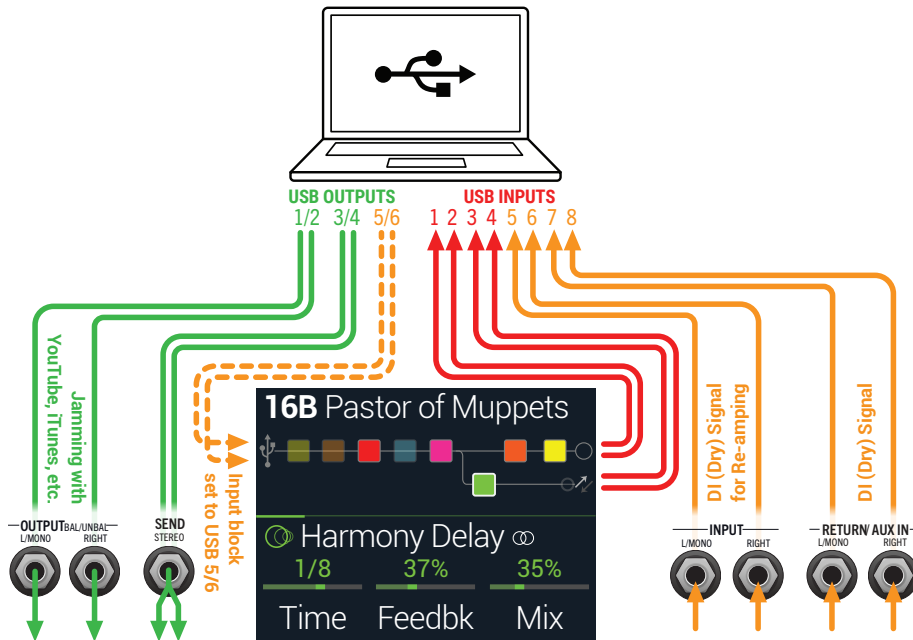

Computer Input	Source
USB 1 and 2	Output of HX Stomp's Path A (with all Path A processing)
USB 3 and 4	Output of HX Stomp's Path B (with all Path B processing)
USB 5 and 6	HX Stomp's Main L/MONO and RIGHT inputs (dry, no processing)
USB 7 and 8	HX Stomp's Return/Aux L/MONO and RIGHT inputs (dry, no processing)

Computer Output	Destination
USB 1/2	HX Stomp's Main L/MONO, RIGHT, and Phones outputs (direct, no processing) for monitoring your DAW's master output or jamming along with YouTube™, iTunes, etc.
USB 3/4	HX Stomp's stereo SEND stereo output (direct, no processing)
USB 5/6	HX Stomp's Input block for re-amping (only active when Input block is set to USB 5/6)
USB 7/8	The never-ending abyss (reserved for future use)

Hardware Monitoring vs. DAW Software Monitoring

HX Stomp provides *hardware monitoring*, which lets you hear your live input signal at all times, independent of your DAW software's monitor settings. Hardware monitoring can be desirable since it allows you to hear your live guitar with HX processing added and essentially "latency-free," since the monitor signal is not routed through your DAW software.

In some DAW recording scenarios, it may be preferable to utilize your recording application's "input monitoring" or "software monitoring" feature, which routes your live input signal through the armed recording track, thus allowing you to monitor the input effected by any plugins you may have inserted on the track. The one downside of DAW software monitoring, however, is that your live input signal will be delayed slightly due to being routed through the software and back to HX Stomp's outputs, which is referred to as "latency." HX Stomp is designed to provide very low latency operation— see "[ASIO Driver Settings \(Windows only\)](#)" for info and settings.

When a DAW track's software monitoring is active, you'll likely **not** want to hear the HX Stomp hardware monitoring signal simultaneously. To achieve this, it is best to use the HX Stomp USB 5/6 inputs as your DAW audio track's input source and select the Main L/R Output block on HX Stomp and turn its Level all the way down. This configuration allows you to hear and record only the dry, DI signal from HX Stomp into your audio track. (See the next section for more on recording a DI track.)

DI Recording and Re-amping

A common DAW recording technique is to record a dry DI (Direct Input) signal, such as the unprocessed signal from your guitar. This lets you process the DI track later with plugins (such as the [Helix Native plugin](#)), and/or “re-amp” the DI track through an amp or other outboard gear. HX Stomp has handy options built right in for recording DI tracks, as well as for easy re-amplification of DI tracks back through your own HX Stomp tones, all without extra hardware or cabling!

HX Stomp offers two special DI outputs—USB Outs 5 and 6, which are fed directly from the Main L/MONO and RIGHT inputs. Also, note that USB Outs 7 and 8 are fed directly (unprocessed) from the Return/Aux In L/MONO and RIGHT inputs for simultaneously tracking a stereo digital piano, synth, drum machine, or other device.

Recording a Dry DI Track

For this example, we’ll record guitar into two DAW tracks simultaneously, with one capturing the processed tone and the other the unprocessed DI guitar.

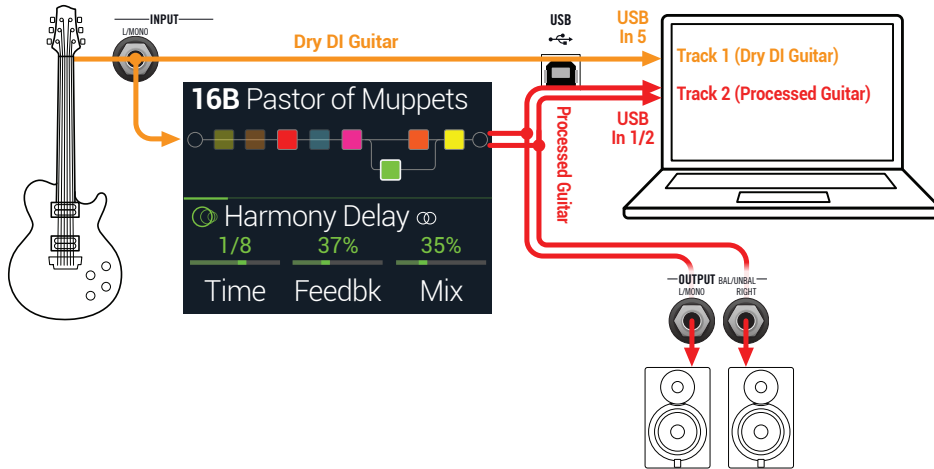

1. Create two new audio tracks in your DAW software project:

Create one mono track to record the dry DI guitar, and set the track’s input to HX Stomp USB 5.

Create one stereo track to record your full, stereo, processed tone and set the track’s input to HX Stomp USB 1/2.

2. Set both tracks’ outputs, as well as the DAW Master output to HX Stomp USB 1/2 to allow all tracks to play back through HX Stomp.

NOTE: Setting the stereo track’s output to HX Stomp’s USB 1/2 allows you to hear your processed tone via HX Stomp’s hardware monitoring while recording. For this configuration, disable software input monitoring on all DAW tracks.

3. Arm both these DAW audio tracks, hit the Record button and start laying down your guitar performance!

Now you have your processed track to hear with the project and a separate DI track with which you can further experiment at any time with DAW plugins and/or re-amping (see the next section).

Re-amping Through HX Stomp

Now let’s take the dry DI guitar track we recorded and route it back through HX Stomp for processing.

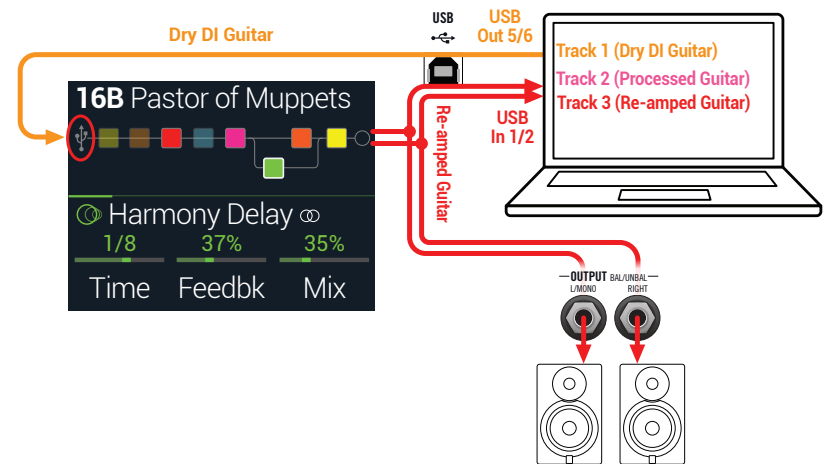

1. From Play view, turn the Upper Knob to select the Input block and then turn the Lower Knob to choose “Input USB 5/6.”

You’ll see that a small USB icon has replaced the Input block (also see [“Signal Present and Clip Indicators”](#)):

INPUT MAIN L/R



INPUT USB 5/6

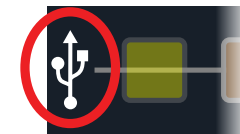

2. In your DAW software, set the DI track's Output setting to HX Stomp USB 5/6.
3. Create a new stereo track in your DAW project and set both its Input and Output to USB 1/2. Arm the track for recording.

NOTE: In some DAW software, it may be necessary to also activate the software monitoring feature on this "re-amped" track to monitor the processed signal when playing back your project. See your software's documentation.

4. Now play your DAW project and you'll hear the DI track "re-amped" through HX Stomp! Tweak your amp & effects blocks as desired while listening with the playback of your project mix.
5. Once you have your re-amplified guitar tone they way you like it, Solo both the DI and re-amped tracks, rewind to the start of the project and hit the DAW Record button, allowing it to capture the signal into the new re-amped track in real-time.

Allow the DI track to play to the end, stop recording, and you've created your new re-amped guitar track!

TIP: Note that you still have your original Guitar DI track, and you can repeat this process to create additional re-amped tracks with different HX Stomp settings, add plugins, blend with your original guitar track, and more.

Re-amping is powerful but really slow. Isn't there an easier way?

Absolutely! Instead of routing your dry DI guitar tracks through HX Stomp and then re-tracking everything in real-time (something that can take forever if you have a long song with many guitar and bass tracks to re-amp), you can simply insert the Line 6 [Helix Native plugin](#) on each track. Helix Native lets you apply the DSP horsepower of HX Stomp to any of your production's tracks (including vocals, keyboards, synths, drums, busses, or more), without having to deal with routing or re-amping. You can also export any of your HX Stomp device presets and import them directly into Helix Native plugin!

Core Audio Driver Settings (macOS only)

To use HX Stomp as an audio interface for Mac applications, it is unnecessary to install any additional driver. HX Stomp will automatically utilize the Mac computer's "Class Compliant" USB driver when connected to your USB port. HX Stomp will then appear as a selectable Core Audio device within the Mac Utilities > Audio MIDI Setup panel and/or directly within your DAW host and multimedia applications. However, note that this Apple Class Compliant driver offers strictly 48kHz native sample rate operation. If you prefer to use a different native sample rate (or if your particular DAW application requires it), you can optionally download and install the Line 6 Helix Mac Core Audio driver from line6.com/software. This Line 6 driver supports HX Stomp, as well as all Helix devices, and offers 44.1kHz, 48kHz, 88kHz, or 96kHz sample rate operation.

ASIO Driver Settings (Windows only)

When using HX Stomp as an audio interface for Windows DAW applications, it is highly recommended to configure the software to utilize the HX Stomp "ASIO" driver. The Line 6 HX Stomp ASIO driver offers the superior, low-latency audio performance required for DAW recording. This driver selection is typically found in your DAW software's Preferences or Options dialog - see your software's documentation.

NOTE: Download and install the latest Line 6 HX Stomp ASIO driver from line6.com/software.

Once the HX Stomp ASIO driver has been selected in your DAW software, you'll also see a button in the same dialog for "ASIO Settings" (or with a similar title). Press this button to launch the HX Stomp Control Panel, where you make the following driver settings.

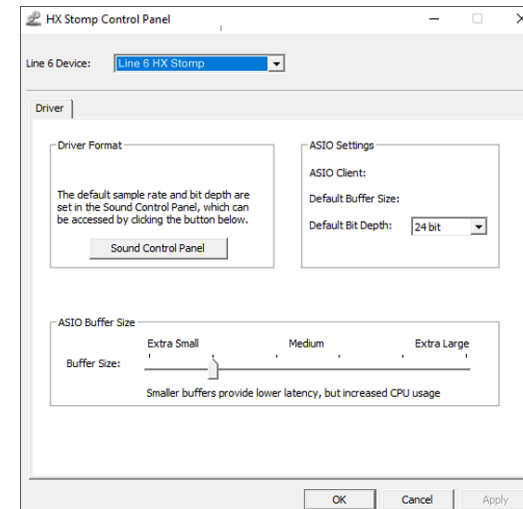

Sound Control Panel This button launches the Windows Sound Control Panel, which is where you can optionally configure HX Stomp to be the audio playback device for multimedia applications (such as Windows Media Player, iTunes, etc.) The settings within the Windows Sound Control Panel are not relevant for your DAW software since standard multimedia applications utilize the standard Windows driver.

Default Bit Depth Select the Bit Depth at which HX Stomp will operate for recording and playback with your DAW software. 24 bit or 32 bit are recommended for quality audio production.

ASIO Buffer Size Your goal is to achieve the lowest latency possible in your DAW software, but with glitch-free audio performance. Smaller buffer size results in lower latency, however, it also increases the demands on your computer, which can result in clicks, pops, or other audio artifacts. Start with a lower slider setting here and if you encounter audio performance issues, come back to this panel and move this slider to the right incrementally to remedy the problem.

Click the Apply and OK buttons when your HX Stomp Control Panel settings are complete to return to your DAW software. Please also refer to your DAW software's documentation for more about its own specific audio device, buffer, and project settings.

MIDI

NOTE: HX Stomp transmits and responds to MIDI messages over USB in the same manner as via its MIDI connectors. For USB MIDI operation on Windows computers, it is necessary to download and install the Line 6 HX Stomp ASIO driver, available from line6.com/software. There is no driver installation necessary for Mac computers or iPad or iPhone devices.

Preset and Snapshot Recall via MIDI

MIDI can be frustrating enough as it is without having to slog through a manual to figure out what messages your particular device needs to change presets. Conveniently enough, HX Stomp has handy helper text to tell you exactly which MIDI messages will recall the current preset and snapshot.

1. If not already there, press **VIEW** to select Play view.
2. Press the Upper Knob to open the Preset list:

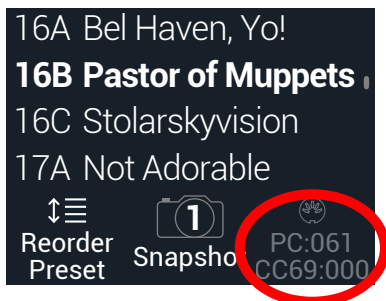

The dark text above Knob 3 displays the required MIDI messages for recalling presets and/or snapshots from external MIDI devices or software. In the illustration above, the 16B Pastor of Muppets preset is recalled with a PC (program change) message of 061, and Snapshot 1 is recalled with a CC69 message of 000.

NOTE: HX Stomp responds to MIDI channel 1 by default, but this can be changed from "[Global Settings > MIDI/Tempo](#)".

NOTE: When selecting different presets, HX Stomp automatically transmits a MIDI Program Change message corresponding to the selected preset. If you'd prefer not to automatically transmit PC messages, set "[Global Settings > MIDI/Tempo](#)" > MIDI PC Tx to "Off."

Block Bypass via MIDI

1. Press **PAGE** and **PAGE** together to open the Menu.
2. Press **Knob 1 (Bypass Assign)**.
3. Turn the **Upper Knob** to select the block whose bypass you want to assign to incoming MIDI.
4. Press **PAGE** and then **Knob 3 (Learn)**. Send a MIDI CC message from your foot controller, keyboard, etc.

The CC number appears above Knob 1 (MIDI In).

Incoming CC values 0-63 turn the block off; values 64-127 turn the block on. Note that some MIDI CCs are reserved for global functions and cannot be selected (see "[MIDI CC](#)").

NOTE: To manually select a MIDI CC, instead of step 4 above, press **PAGE** and turn **Knob 1 (MIDI In)** to select the desired MIDI CC number.

Parameter Control via MIDI

1. From Edit view, press and hold the knob for the parameter you wish to control.

HX Stomp jumps to the Controller Assign page and displays your parameter at Knob 1 (Parameter).

2. Press **PAGE** and then **Knob 3 (Learn)**. Send a MIDI CC message from your foot controller, keyboard, etc.

The CC number appears above Knob 3 (CC#).

NOTE: To manually select a MIDI CC, turn **Knob 2 (Controller)** to select "MIDI CC" and **Knob 3** to the desired MIDI CC number.

3. If desired, press **PAGE** and turn **Knob 1 (Min Value)** and **Knob 2 (Max Value)** to set the range you wish to control.

TIP: To reverse controller behavior, swap the min and max values.

4. Press when finished. Remember to save your preset to retain all assignments!

Synchronizing Tempo via MIDI

Certain Delay and Modulation parameters such as Time and Speed can be represented with fixed numeric values (ms or Hz) or note values (1/4-note, dotted 1/8-note, etc.). When set to note values, the parameter will follow Tap Tempo or incoming MIDI clock. **Press the parameter knob to toggle between ms (or Hz) and note values.**

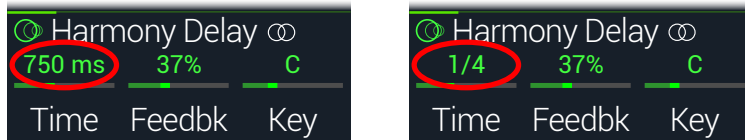

By default, HX Stomp responds to **MIDI clock** received from external gear (or your DAW software via USB). HX Stomp can also transmit MIDI clock to external gear or software (transmit is disabled by default). MIDI clock reception (Rx) and transmission (Tx) can be enabled or disabled from the ["Global Settings > MIDI/Tempo"](#) menu.

In addition, certain modulation effects have distinct rhythmic elements; for example, a tremolo set to a square wave (sometimes called a "slicer") not only has a tempo but a beat, where the upswing of the wave lands with relation to your song. That is, the effect may be in perfect tempo-sync with your song, but its "downbeat" may be shifted ahead or behind of your drummer's—or in the studio, your recorded song's—downbeat.

From Stomp or Scroll mode, on the downbeat of your song, press TAP once.

Any beat sync-based (sometimes called "LFO") effects reset from the beginning.

MIDI CC

HX Stomp has reserved specific MIDI CC messages for global functions; these CCs cannot be used as controllers. If you attempt to learn a CC message reserved for global functions (see ["Controller Assign"](#)), the following dialog appears:

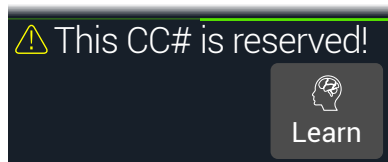

MIDI CC#	Value	Function
Pedal and Footswitch Assignments		
1	0-127	Emulates EXP 1 Pedal
2	0-127	Emulates EXP 2 Pedal
49	0-127	Emulates FS1
50	0-127	Emulates FS2
51	0-127	Emulates FS3
52	0-127	Emulates FS4
53	0-127	Emulates FS5
1 Switch Looper Controls		
60	0-63: Overdub; 64-127: Record	1 Switch Looper Record/Overdub
61	0-63: Stop; 64-127: Play	1 Switch Looper Play/Stop
62	64-127	1 Switch Looper Play Once
63	64-127	1 Switch Looper Undo/Redo
65	0-63: Forward; 64-127: Reverse	1 Switch Looper Forward/Reverse
66	0-63: Full; 64-127: Half	1 Switch Looper Full/Half Speed
Additional Controls		
0	n/a	Bank MSB (unused, but reserved)
32	n/a	Bank LSB (unused, but reserved)
64	64-127	Tap Tempo
68	0-127	Tuner screen on/off
69	0-2, 8 and 9	Snapshot select (0=Snapshot 1, 1=Snapshot 2, 2=Snapshot 3, 8=Next snapshot, 9=Previous snapshot)
70	0-63: Bypass; 64-127: On	All Bypass
71	0-5	Footswitch Mode (0=Stomp, 1=Scroll, 2=Preset, 3=Snapshot, 4=Next footswitch mode, 5=Previous footswitch mode)

MIDI CC#	Value	Function
3	0-127	Additional global MIDI commands (reserved for future use)
54	0-127	
55	0-127	
56	0-127	
57	0-127	
58	0-127	
59	0-127	
67	0-127	
72	0-127	
73	0-127	
74	0-127	
75	0-127	
76	0-127	
128	0-63: Jealous; 64-127: Co-dependent	HX Stomp sends late-night texts to all of your ex-significant others, professing your undying love to them and their cats

Additional Resources

Looking for more info? We've got plenty of online resources, just a click away.

- Download additional Help documentation covering Helix family devices and software from the Line 6 website at [Line 6 Product Manuals](#)
- Check out the [Line 6 Support](#) page for access to helpful tips, videos, discussion forums, or to contact Line 6 Technical Support
- Stay up to date with the latest updated version of HX Edit, Helix Native, and all your other Line 6 applications, available from the [Line 6 Software Downloads](#) page
- Visit the [Line 6 CustomTone](#) site where you can share your Helix presets with the world, and download free presets created by Line 6 and other users just like you
- Check out the ever-growing selection of premium add-ons for the family of Helix products available on [Helix Marketplace](#)
- Can't get enough Line 6 Gear & accessories? Head on over to the [Line 6 Store](#)

